

JV-1010

64VOICE SYNTHESIZER MODULE
"Session" onboard + EXPANDABLE

OWNER'S MANUAL

Thank you, and congratulations on your choice of the Roland JV-1010 64 Voice Synthesizer Module.

In order to get a good understanding of the JV-1010's many outstanding features and ensure many years of trouble-free use, please be sure to read through this manual in its entirety.

Before using this unit, carefully read the sections entitled: "USING THE UNIT SAFELY" (p. 2-4) and "IMPORTANT NOTES" (p. 5, 6). These sections provide important information concerning the proper operation of the unit. Additionally, in order to feel assured that you have gained a good grasp of every feature provided by your new unit, Owner's manual should be read in its entirety. The manual should be saved and kept on hand as a convenient reference.

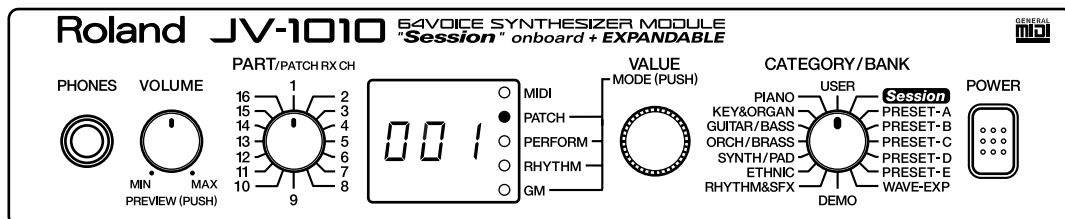

- * Apple is a registered trademark of Apple Computer, Inc.
- * Macintosh is a registered trademark of Apple Computer, Inc.
- * Emagic and SoundDiver are registered trademarks of Emagic GmbH.

Copyright © 1999 ROLAND CORPORATION

All rights reserved. No part of this publication may be reproduced in any form without the written permission of ROLAND CORPORATION.

IMPORTANT: THE WIRES IN THIS MAINS LEAD ARE COLOURED IN ACCORDANCE WITH THE FOLLOWING CODE.



BLUE: NEUTRAL
BROWN: LIVE



As the colours of the wires in the mains lead of this apparatus may not correspond with the coloured markings identifying the terminals in your plug, proceed as follows:

The wire which is coloured BLUE must be connected to the terminal which is marked with the letter N or coloured BLACK.
The wire which is coloured BROWN must be connected to the terminal which is marked with the letter L or coloured RED.
Under no circumstances must either of the above wires be connected to the earth terminal of a three pin plug.







USING THE UNIT SAFELY

INSTRUCTIONS FOR THE PREVENTION OF FIRE, ELECTRIC SHOCK, OR INJURY TO PERSONS

About  WARNING and  CAUTION Notices

 WARNING	Used for instructions intended to alert the user to the risk of death or severe injury should the unit be used improperly.
 CAUTION	Used for instructions intended to alert the user to the risk of injury or material damage should the unit be used improperly. * Material damage refers to damage or other adverse effects caused with respect to the home and all its furnishings, as well to domestic animals or pets.

About the Symbols

	The  symbol alerts the user to important instructions or warnings. The specific meaning of the symbol is determined by the design contained within the triangle. In the case of the symbol at left, it is used for general cautions, warnings, or alerts to danger.
	The  symbol alerts the user to items that must never be carried out (are forbidden). The specific thing that must not be done is indicated by the design contained within the circle. In the case of the symbol at left, it means that the unit must never be disassembled.
	The  symbol alerts the user to things that must be carried out. The specific thing that must be done is indicated by the design contained within the circle. In the case of the symbol at left, it means that the power-cord plug must be unplugged from the outlet.

ALWAYS OBSERVE THE FOLLOWING



WARNING

- Before using this unit, make sure to read the instructions below, and the Owner's Manual. 

- Do not open or perform any internal modifications on the unit or its AC adaptor. (The only exception would be where this manual provides specific instructions which should be followed in order to put in place user-installable options; see p. 16.) 

- Do not attempt to repair the unit, or replace parts within it (except when this manual provides specific instructions directing you to do so). Refer all servicing to your retailer, the nearest Roland Service Center, or an authorized Roland distributor, as listed on the "Information" page. 









WARNING

- Never use or store the unit in places that are:
 - Subject to temperature extremes (e.g., direct sunlight in an enclosed vehicle, near a heating duct, on top of heat-generating equipment); or are 
 - Damp (e.g., baths, washrooms, on wet floors); or are 
 - Humid; or are
 - Exposed to rain; or are
 - Dusty; or are
 - Subject to high levels of vibration.





- This unit should be used only with a rack or stand that is recommended by Roland. 

- When using the unit with a rack or stand recommended by Roland, the rack or stand must be carefully placed so it is level and sure to remain stable. If not using a rack or stand, you still need to make sure that any location you choose for placing the unit provides a level surface that will properly support the unit, and keep it from wobbling. 

⚠ WARNING











- Be sure to use only the AC adaptor supplied with the unit. Also, make sure the line voltage at the installation matches the input voltage specified on the AC adaptor's body. Other AC adaptors may use a different polarity, or be designed for a different voltage, so their use could result in damage, malfunction, or electric shock. 

- Avoid damaging the power cord. Do not bend it excessively, step on it, place heavy objects on it, etc. A damaged cord can easily become a shock or fire hazard. Never use a power cord after it has been damaged. 
- This unit, either alone or in combination with an amplifier and headphones or speakers, may be capable of producing sound levels that could cause permanent hearing loss. Do not operate for a long period of time at a high volume level, or at a level that is uncomfortable. If you experience any hearing loss or ringing in the ears, you should immediately stop using the unit, and consult an audiologist. 
- Do not allow any objects (e.g., flammable material, coins, pins); or liquids of any kind (water, soft drinks, etc.) to penetrate the unit. 

- Immediately turn the power off, remove the AC adaptor from the outlet, and request servicing by your retailer, the nearest Roland Service Center, or an authorized Roland distributor, as listed on the "Information" page when:
 - The AC adaptor or the power-supply cord has been damaged; or
 - Objects have fallen into, or liquid has been spilled onto the unit; or
 - The unit has been exposed to rain (or otherwise has become wet); or
 - The unit does not appear to operate normally or exhibits a marked change in performance.
- In households with small children, an adult should provide supervision until the child is capable of following all the rules essential for the safe operation of the unit. 
- Protect the unit from strong impact. (Do not drop it!) 

⚠ WARNING

- Do not force the unit's power-supply cord to share an outlet with an unreasonable number of other devices. Be especially careful when using extension cords—the total power used by all devices you have connected to the extension cord's outlet must never exceed the power rating (watts/ amperes) for the extension cord. Excessive loads can cause the insulation on the cord to heat up and eventually melt through. 
- Before using the unit in a foreign country, consult with your retailer, the nearest Roland Service Center, or an authorized Roland distributor, as listed on the "Information" page. 
- Always turn the unit off and unplug the AC adaptor before attempting installation of the circuit board (SR-JV80 series). 
- DO NOT play a CD-ROM disc on a conventional audio CD player. The resulting sound may be of a level that could cause permanent hearing loss. Damage to speakers or other system components may result. 

USING THE UNIT SAFELY

CAUTION

- The unit and the AC adaptor should be located so their location or position does not interfere with their proper ventilation. 
- Always grasp only the plug or the body of the AC adaptor when plugging into, or unplugging from, an outlet or this unit. 
- Whenever the unit is to remain unused for an extended period of time, disconnect the AC adaptor. 
- Try to prevent cords and cables from becoming entangled. Also, all cords and cables should be placed so they are out of the reach of children. 
- Never climb on top of, nor place heavy objects on the unit. 
- Never handle the AC adaptor body, or its plugs, with wet hands when plugging into, or unplugging from, an outlet or this unit. 
- Before moving the unit, disconnect the AC adaptor and all cords coming from external devices. 
- Before cleaning the unit, turn off the power and unplug the AC adaptor from the outlet. 
- Whenever you suspect the possibility of lightning in your area, disconnect the AC adaptor from the outlet. 
- Install only the specified circuit board(s) (SR-JV80 series). Remove only the specified screws (p. 16). 

Important Notes

In addition to the items listed under “USING THE UNIT SAFELY” on page 2, please read and observe the following:

■ Power Supply

- Do not use this unit on the same power circuit with any device that will generate line noise (such as an electric motor or variable lighting system).
- The AC adaptor will begin to generate heat after long hours of consecutive use. This is normal, and is not a cause for concern.
- Before connecting this unit to other devices, turn off the power to all units. This will help prevent malfunctions and/or damage to speakers or other devices.

■ Placement

- This device may interfere with radio and television reception. Do not use this device in the vicinity of such receivers.
- To avoid possible breakdown, do not use the unit in a wet area, such as an area exposed to rain or other moisture.

■ Maintenance

- For everyday cleaning wipe the unit with a soft, dry cloth or one that has been slightly dampened with water. To remove stubborn dirt, use a cloth impregnated with a mild, non-abrasive detergent. Afterwards, be sure to wipe the unit thoroughly with a soft, dry cloth.
- Never use benzene, thinners, alcohol or solvents of any kind, to avoid the possibility of discoloration and/or deformation.

■ Repairs and Data

- Please be aware that all data contained in the unit’s memory may be lost when the unit is sent for repairs. Important data should always be backed up in another MIDI device (e.g., a sequencer), or written down on paper (when possible). During repairs, due care is taken to avoid the loss of data. However, in certain cases (such as when circuitry related to memory itself is out of order), we regret that it may not be possible to restore the data, and Roland assumes no liability concerning such loss of data.

■ Memory Backup

- This unit contains a battery which powers the unit’s memory circuits while the main power is off. When this battery becomes weak, the message shown below will appear in the display. Once you see this message, have the battery replaced with a fresh one as soon as possible to avoid the loss of all data in memory. To have the battery replaced, consult with your retailer, the nearest Roland Service Center, or an authorized Roland distributor, as listed on the “Information” page.

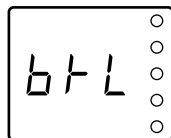

■ Additional Precautions

- Please be aware that the contents of memory can be irretrievably lost as a result of a malfunction, or the improper operation of the unit. To protect yourself against the risk of losing important data, we recommend that you periodically save a backup copy of important data you have stored in the unit's memory in another MIDI device (e.g., a sequencer).
- Unfortunately, it may be impossible to restore the contents of data that was stored in the unit's memory or another MIDI device (e.g., a sequencer) once it has been lost. Roland Corporation assumes no liability concerning such loss of data.
- Use a reasonable amount of care when using the unit's buttons, sliders, or other controls; and when using its jacks and connectors. Rough handling can lead to malfunctions.
- When connecting / disconnecting all cables, grasp the connector itself—never pull on the cable. This way you will avoid causing shorts, or damage to the cable's internal elements.
- To avoid disturbing your neighbors, try to keep the unit's volume at reasonable levels. You may prefer to use headphones, so you do not need to be concerned about those around you (especially when it is late at night).
- When you need to transport the unit, package it in the box (including padding) that it came in, if possible. Otherwise, you will need to use equivalent packaging materials.

■ Handling CD-ROMs

- Avoid touching or scratching the shiny underside (encoded surface) of the disc. Damaged or dirty CD-ROM discs may not be read properly. Keep your discs clean using a commercially available CD cleaner.

How to Read This Owner's Manual

This owner's manual is organized as follows.

Quick Start

This section is intended for those using the JV-1010 for the first time, and explains how to use various functions in a simple way. Please read **Quick Start** and follow along by actually operating the JV-1010. This will help you understand most of what you need to know for basic operations.

Appendices

This chapter contains a troubleshooting section for use when the JV-1010 is not functioning as expected. There is also a list of error messages that you can refer to if an error message appears on the display. A list of patches and MIDI implementation chart are also provided.

■ Notation Used in This Owner's Manual

An asterisk (*) at the beginning of a paragraph indicates a note or precaution. These should not be ignored. In the Quick Start section, such material is indicated by (NOTE).

(p. **) refers to pages within the manual.

Although the JV-1010 cannot be used on its own for creating sounds, using the Emagic **SoundDiver JV/XP** on the CD-ROM included with the JV-1010 allows you to create original sounds. For more on the operation of **SoundDiver JV/XP**, refer to **SoundDiver JV/XP Help**.

Furthermore, the Reference Manual that is on the included CD-ROM explains the workings of patches, performances, rhythm set parameters, and the system parameters that determine the JV-1010's operating environment, along with descriptions of the parameters. Be sure to refer to this manual this when creating sounds.

Contents

Main Features	10
Front and Rear Panel	11
Quick Start	13
Getting Ready to Play	14
Attaching the Rubber Feet.....	14
Installing on the Rack-Mount Adaptor	14
Installing a Wave Expansion Board.....	15
How to Install a Wave Expansion Board.....	15
Making the Connections.....	18
Switching the Power On and Off.....	20
Switching On the Power	20
Switching Off the Power	20
Reset to Default Factory Settings (Factory Reset)	21
Listening to Demo Songs (Demo Play)	22
Composer Profiles.....	23
Choosing and Playing Patches	24
Auditioning Patches (Phrase Preview).....	25
Playing Notes from a MIDI Keyboard	26
Choosing Patches.....	27
Choosing Patches by Bank.....	27
Choosing Patches by Category.....	28
Playing Percussion Sounds	29
Using the JV-1010 as the GM Sound Module	31
Entering GM Mode.....	31
Changing Sounds from an External MIDI Device	32
Note on Using an External MIDI Device to Switch Sounds	32
Changing Patches	32
Changing a Performance	34
Changing a Rhythm Set.....	36
Trying Out Desktop Music	38
Connecting to a Computer.....	38
Connecting to the COMPUTER Connector	38
Connecting with MIDI Connectors	41
Performing Multiple Parts (Performance Mode).....	42
Editing Using Only the JV-1010	44
Making Part Settings (PART).....	44
Memory-Related Operations (UTILITY).....	45
Restoring the Factory Settings (Factory Reset)	45
Initializing GM Mode (GM Initialize)	46
Initializing the Settings (Initialize)	47
Transmitting Settings to an External MIDI Device (Data Transfer)	48
Making System Settings (SYSTEM)	49
Selecting the Receive Channel (Perform Ctrl CH)	49
Tuning (Master Tune).....	50

Appendices.....	51
Troubleshooting.....	52
Error Messages	53
Patch List.....	54
Patch Category List	58
Rhythm Set List.....	64
Performance List.....	67
MIDI Implementation	68
Specifications.....	89
Computer Cable Wiring Diagrams.....	90
Index.....	91

Main Features

■ Incorporates the JV-1080 Sound Module

The JV-1010 is a 16-part multitimbral internal sound generator that can generate up to 64 voices simultaneously, and is equipped with a multi-effects processor (EFX) offering a total of 40 different effects.

The Preset patches are compatible not only with the JV-1080 and the XP-30/50/60/80, but with the JV-2080 as well.

The General MIDI system is also supported.

General MIDI System

The General MIDI system is a set of recommendations which seeks to provide a way to go beyond the limitations of proprietary designs, and standardize the MIDI capabilities of sound generating devices. Sound generating devices and music files that meets the General MIDI standard bears the General MIDI logo (). Music files bearing the General MIDI logo can be played back using any General MIDI sound generating unit to produce essentially the same musical performance (p. 31).

■ SR-JV80-09 “Session” Waves and Patch Data Onboard

There are total of 1,023 onboard sounds, including the user patches, presets A through E, and session sounds.

■ SR-JV80 Series Wave Expansion Boards Can Be Installed

A SR-JV80 series Wave Expansion Board can be installed, enabling expansion of sounds using the SR-JV80 series.

■ Equipped with Computer Connector

By connecting the instrument to a computer, you can enjoy full-fledged editing.

■ Easy-to-understand, Easy-to-use Operations and Other Useful Features

You can use the CATEGORY/BANK knob to choose sounds by category.

There is a **Phrase Preview** that lets you audition patches through phrases, using just the JV-1010.

Front and Rear Panel

Front Panel

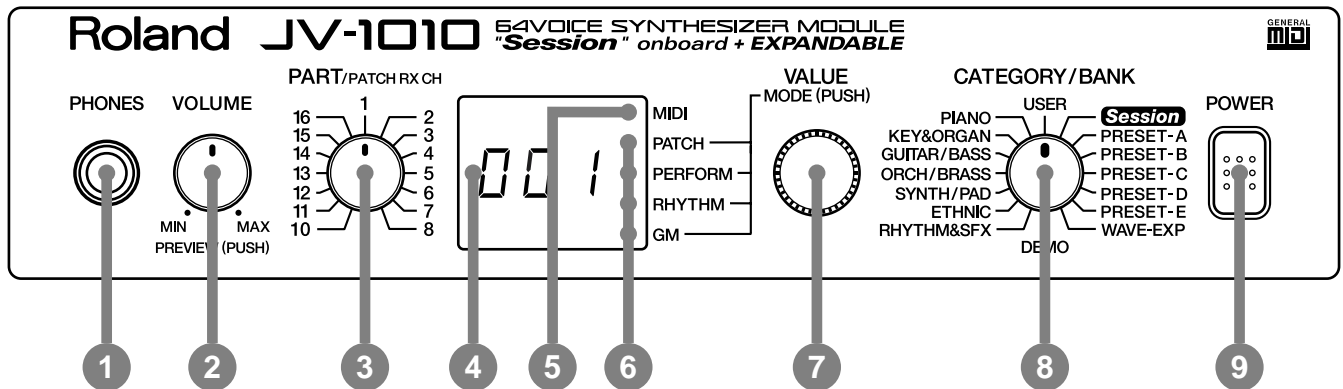

1. PHONES Jack

This is the jack for connecting headphones (sold separately).

* Use headphones with an impedance of 8 to 150 Ohms.

2. VOLUME Knob

This adjusts the volume level for the OUTPUT jack and the PHONES jack. You can also check out a sound using the JV-1010 alone by pressing the VOLUME knob (Phrase Preview, p. 25). When in a mode other than the Patch mode, pressing the VALUE knob while holding down the VOLUME knob switches you to the Edit mode.

3. PART Knob

In the Patch mode, it changes the receive channel. In the Performance mode or the GM mode, it selects the Part to which settings are to be applied.

4. Display

Displays a variety of information about the operation being performed.

5. MIDI Indicator

Lights up when MIDI messages are received.

6. MODE Indicators

The indicator for the currently active mode lights up.

7. VALUE Knob

This changes the setting values for parameters. Turning the knob rapidly makes the value change in larger increments. Pressing the knob switches the mode. When in a mode other than the Patch mode, pressing the VALUE knob while holding down the VOLUME knob switches you to the Edit mode.

8. CATEGORY/BANK Knob

Used to switch the sound selection range.

In the Edit mode, it is used to select the parameter to be set. For more information about the CATEGORY/BANK knob's functions in Edit mode, refer to the **EDIT PARAMETER SELECT** chart on the JV-1010's top panel.

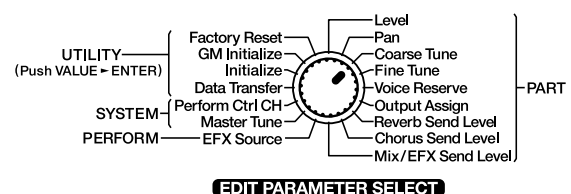

9. POWER Switch

Pressed to switch the power on and off.

Rear Panel

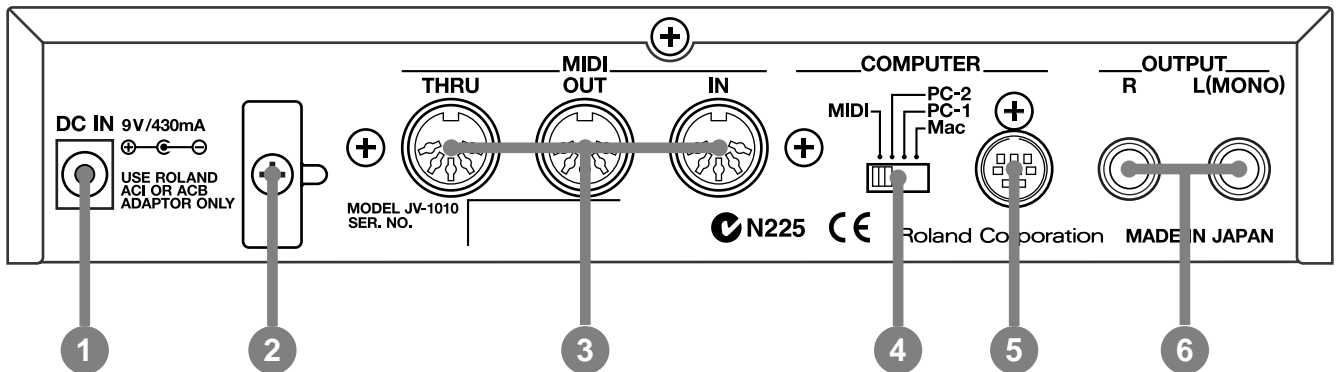

1. AC Adaptor Jack

Accepts connection of the supplied AC adapter.

2. Cord Hook

To prevent the inadvertent disruption of power to your unit (should the plug be pulled out accidentally), and to avoid applying undue stress to the AC adaptor jack, anchor the power cord using the cord hook, as shown in the illustration.

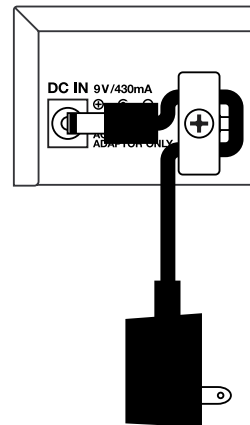

3. MIDI Connectors (IN, OUT, THRU)

These connectors are used to connect the JV-1010 with other devices for sending and receiving MIDI messages.

When using these connectors to exchange MIDI messages, set the COMPUTER switch to **MIDI**.

MIDI IN: This receives information from other MIDI instruments.

MIDI OUT: This sends information from the JV-1010.

MIDI THRU: This sends out, unaltered, information received from MIDI IN.

4. COMPUTER Switch (Mac, PC-1, PC-2, MIDI)

The switch should be set as appropriate for the type of computer connected to the COMPUTER Connector, and the software being used (p. 38).

When using the MIDI connectors, set this to **MIDI**.

* Turn off the power before changing this switch's setting.

5. COMPUTER Connector

This is for connecting a computer to the JV-1010 using a computer cable (sold separately) (p. 38). Set the COMPUTER switch to **Mac** or **PC-2**.

6. OUTPUT Jacks (L (MONO), R)

These are for stereo (L/R) output of audio signals to an amp or a mixer. For monaural output, connect to the left (L) jack.

JV-1010

64VOICE SYNTHESIZER MODULE
"Session" onboard + **EXPANDABLE**

Quick Start

Getting Ready to Play

Attaching the Rubber Feet

If you will not be using the separately available RAD-50 rack-mount adaptor, attach the rubber feet that were supplied with the JV-1010, as shown in the figure. Use the small holes on the bottom as a guide for positioning the rubber feet when attaching them.

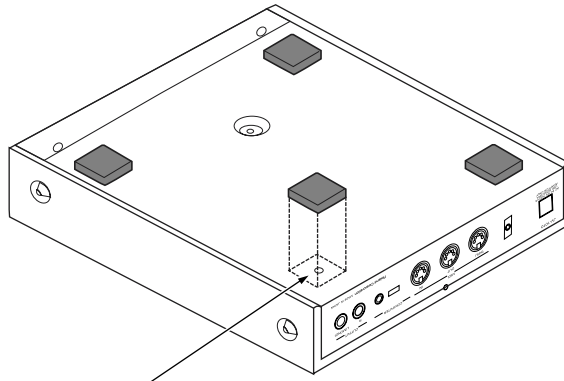

affix the supplied rubber feet onto the bottom of the unit

Installing on the Rack-Mount Adaptor

When installing on the rack-mount adaptor (RAD-50; sold separately), use the screw (M4 x 8) included with the rack-mount adaptor.

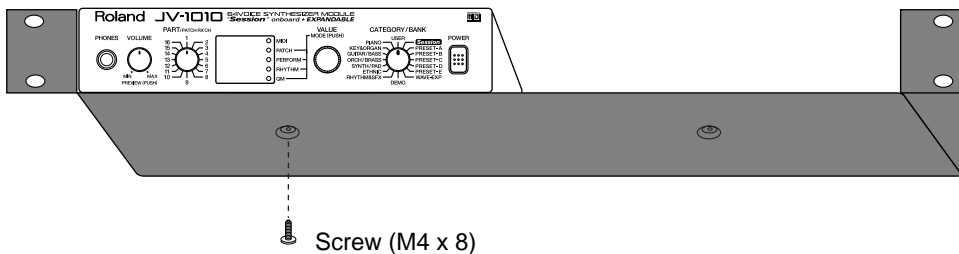

When mounting the unit using the rack-mount adaptor, install it onto the rack-mount adaptor without attaching the rubber feet.

Installing a Wave Expansion Board

One Wave Expansion Board (SR-JV80 series; sold separately) can be installed in the JV-1010.

Waveform data, patches and rhythm sets are stored on the Wave Expansion Board, so you can increase the number of available sounds by installing the board in the JV-1010.

The Wave Expansion Board can be installed by removing the top cover.

■ How to Install a Wave Expansion Board

First, here are some important points to remember when installing into the JV-1010:

- To avoid the risk of damage to internal components that can be caused by static electricity, please carefully observe the following whenever you handle the board.
 - Before you touch the board, always first grasp a metal object (such as a water pipe), so you are sure that any static electricity you might have been carrying has been discharged.
 - When handling the board, grasp it only by its edges. Avoid touching any of the electronic components or connectors.
 - Save the bag in which the board was originally shipped, and put the board back into it whenever you need to store or transport it.
- Do not touch any of the printed circuit pathways or connection terminals.
- Never use excessive force when installing a circuit board. If it doesn't fit properly on the first attempt, remove the board and try again.
- When circuit board installation is complete, double-check your work.
- Install only the specified board, and remove only the specified screws.
- Be careful not to cut your hands on the opening for installing the board.



Installing a Wave Expansion Board increases the patches and drum sets for Parts, but the number of Parts doesn't change.

Getting Ready to Play

Follow the steps below to install the Wave Expansion Board.

1 Before installing the Wave Expansion Board, switch off the power to the JV-1010 and any connected equipment.

2 Detach the cover on the upper portion of the JV-1010. Loosen the four screws on the upper portion of the cover.

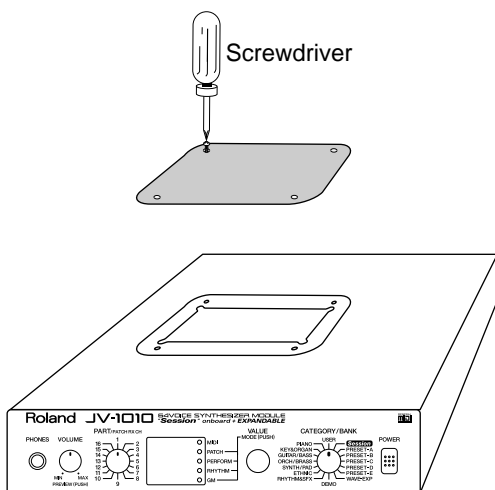

3 Position the board holders so they are oriented.

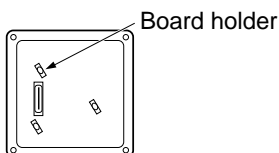

4 Insert the connector for the Wave Expansion Board into the connector on the unit, and at the same time, fit the board holders into the holes. When you do this, the heads of the three board holders should protrude from the Expansion Board.

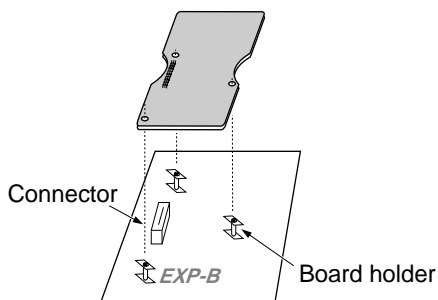

- 5** Use the tool supplied with the Wave Expansion Board to rotate the board holders to LOCK, securing the Wave Expansion Board in place.

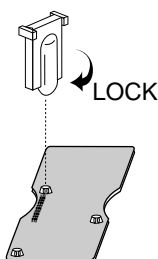

- 6** Use the (specified) screws you removed in step 2 to reattach the cover.

This completes the installation of the Wave Expansion Board. Next, make sure the board is installed correctly.

- 1** Switch on the power to the JV-1010 (p. 20).

- 2** Press the VALUE knob to choose the Patch mode (PATCH).

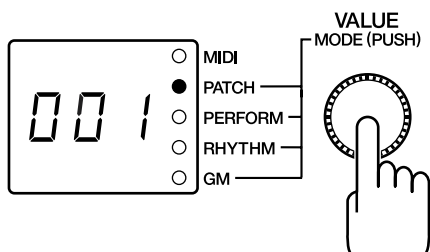

Pressing the VALUE knob makes the mode change sequentially. Press the knob several times, until the PATCH indicator lights up.

- 3** Turn the CATEGORY/BANK knob to choose **WAVE-EXP**.

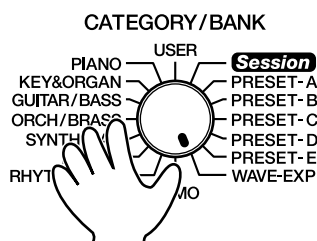

If **001** appears in the display, the Wave Expansion Board has been installed correctly.

MEMO

When a Wave Expansion Board is installed, then when you switch on the power first **roland Jv-1010** is displayed, and after that the final two digits of the model number for the installed Wave Expansion Board flash twice on the display.

For example, when the SR-JV80-02 "Orchestral" Wave Expansion Board is installed, **02** flashes twice on the display.

NOTE

If the display shows **- - -**, it's likely that the Wave Expansion Board is not being recognized correctly. Follow the steps in **"Switching Off the Power"** (p. 20) to switch off the power, then reinstall the Wave Expansion Board, making sure you do it correctly.

Making the Connections

The JV-1010 does not have a built-in amp or speakers. In order to produce sound, you need to hook up audio equipment such as a monitor speaker or a stereo set, or use headphones.

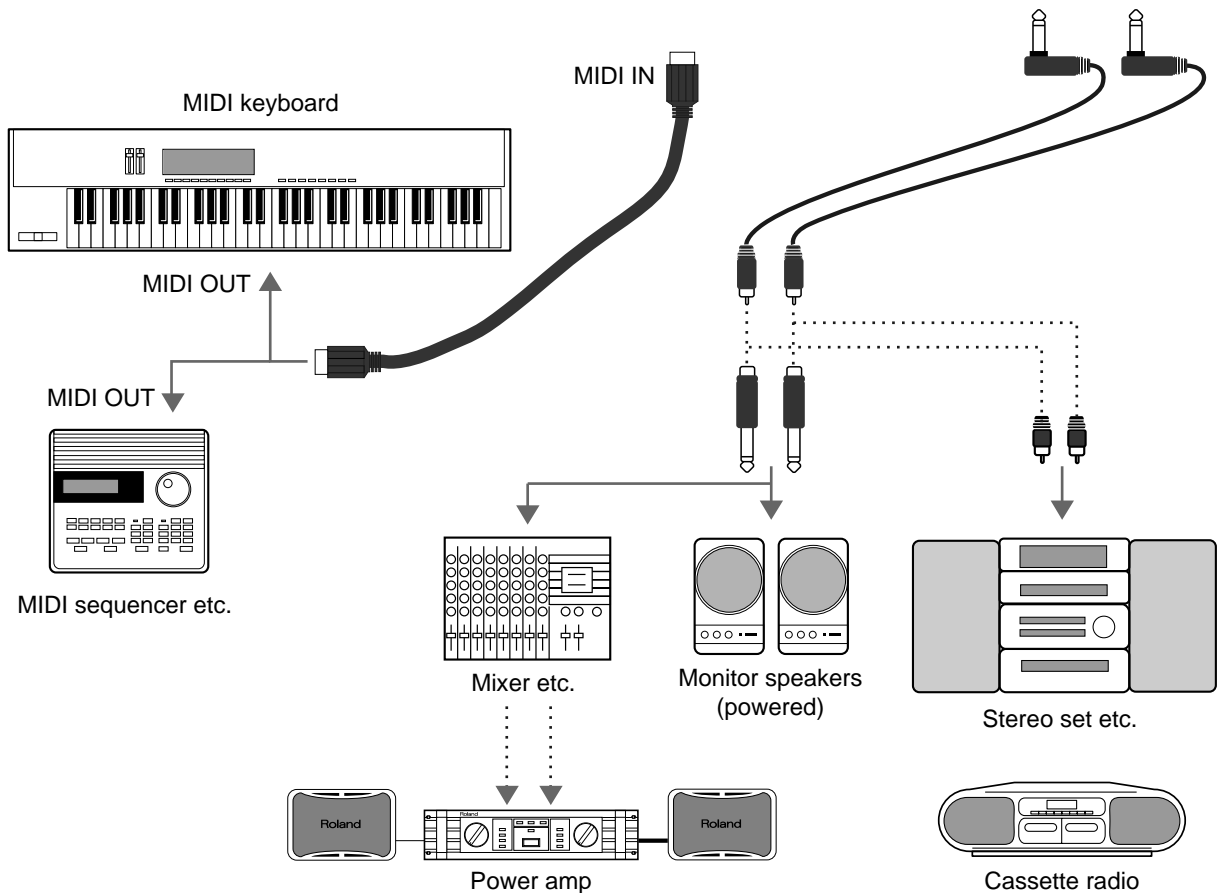
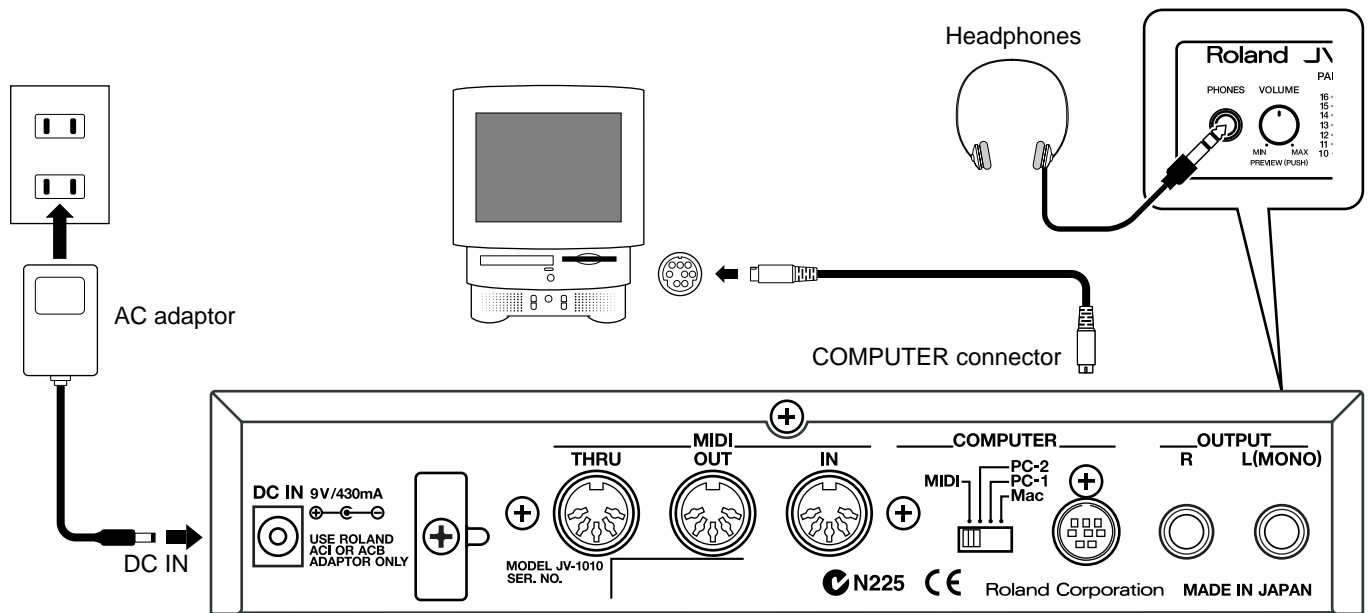

Follow the steps described below to connect the JV-1010 and an external device.

1 Before making the connections, make sure the power to all equipment is switched off.

2 Connect the included AC adaptor to the AC adaptor jack and plug the adaptor into a power outlet.

3 Connect the JV-1010 and the external device as shown in the figure.

Connecting audio equipment: the OUTPUT jacks (L (MONO), R)

Use audio cables (sold separately) to connect the audio device to the OUTPUT jacks on the JV-1010.

Connecting a MIDI keyboard or sequencer: the MIDI connectors (IN, OUT, THRU)

Use a MIDI cable (sold separately) to connect the MIDI OUT connector on the MIDI keyboard or sequencer to the MIDI IN connector on the JV-1010.

Using headphones: the PHONES jack

Plug the headphones (sold separately) into the PHONES jack on the front panel.

Using a computer: the COMPUTER connector

Use a computer cable (sold separately) to connect the computer to the COMPUTER connector on the JV-1010.

NOTE

To prevent malfunction and/or damage to speakers or other devices, always turn down the volume, and turn off the power on all devices before making any connections.

NOTE

We recommend using a stereo connection in order to get the maximum performance from the JV-1010, but for monaural use, make the connection to the L (MONO) OUTPUT jack.

MEMO

For more information on making the connection with the computer, take a look at “Connecting to a Computer” (p. 38).

Switching the Power On and Off

■ Switching On the Power

1 Before you switch on the power, check the following.

- Are peripheral devices connected correctly?
- Is the volume level on the JV-1010 and the connected external equipment turned down all the way?

2 Press the POWER switch on the JV-1010 to switch on the power.

After **roland Jv-1010** is displayed, the unit starts up in the same state it was in when the power was last turned off.

POWER

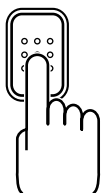

3 Switch on the power to the connected external equipment.

4 Play sounds on the JV-1010 and turn the VOLUME knob to adjust the volume on the JV-1010 and the external equipment.

VOLUME

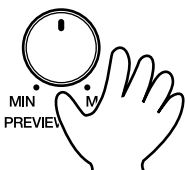

■ Switching Off the Power

1 Before you switch off the power, check the following.

- Is the volume level on the JV-1010 and the connected external equipment turned down all the way?
- Have you saved the sounds or other data you've created? (p. 48)

2 Switch off the power to the connected external equipment.

3 Switch off the POWER switch on the JV-1010.

NOTE

Once the connections have been completed (p. 18), turn on power to your various devices in the order specified. By turning on devices in the wrong order, you risk causing malfunction and/or damage to speakers and other devices.

NOTE

If the power was turned off while in the Rhythm Set mode (RHYTHM), the unit starts up in the Performance mode (PERFORM).

NOTE

This unit is equipped with a protection circuit. A brief interval (a few seconds) after power up is required before the unit will operate normally.

NOTE

Be careful not to turn the volume up too high. Excessive volume levels are not only inconsiderate to others around you, but may damage external equipment or cause hearing loss.

NOTE

Turning the VOLUME knob up all the way may result in distortion for some sounds.

MEMO

You can also play sounds on just the unit itself by pressing the VOLUME knob (Phrase Preview, p.

Reset to Default Factory Settings (Factory Reset)

When using the JV-1010 for the first time, start by returning the settings to their factory defaults so that the JV-1010 operates as described in the procedures in the owner's manual.

This returns all settings stored in memory in the JV-1010 to the values they had when the unit was shipped from the factory.

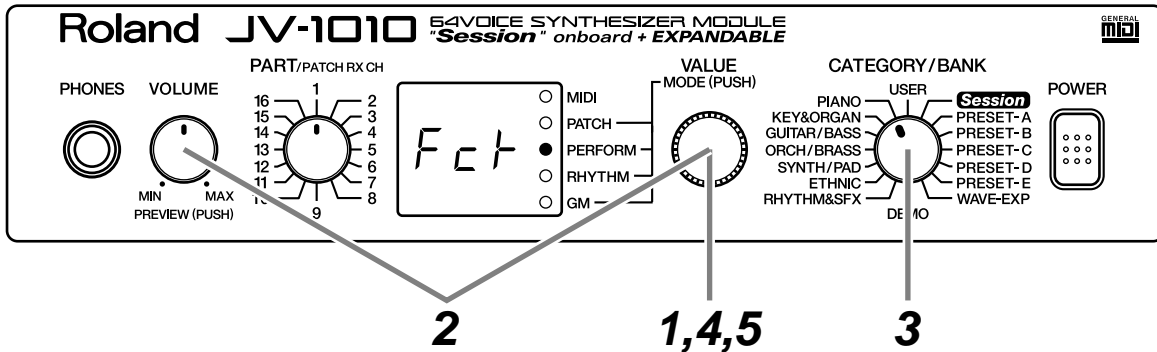

1 Press the VALUE knob to switch to a mode other than the Patch mode (**PATCH**), that is, to the **PERFORM**, **RHYTHM**, or **GM** mode.

2 While holding down the VOLUME knob, press the VALUE knob. Switch to the Edit mode.

3 Turn the CATEGORY/BANK knob to choose **PIANO (Factory Reset)**.

Fct flashes on the display.

In the Edit mode, choosing **PIANO (Factory Reset)** with the CATEGORY/BANK knob makes it possible to perform Factory Reset.

4 Press the VALUE knob.

Sur flashes on the display, prompting you to confirm that you indeed wish to carry out a Factory Reset.

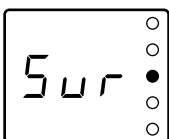

5 Press the VALUE knob.

The Factory Reset is performed, and you leave the Edit mode.

NOTE

If there is important data you've created that's stored in memory, all such data is discarded, and everything is returned to the factory defaults when a Factory Reset is performed. If important data is stored in the unit, save it on an external MIDI device (p. 48).

NOTE

When in the Patch mode, you can't enter the Edit mode.

MEMO

For more information about the CATEGORY/BANK knob's other functions in Edit mode, refer to the **EDIT PARAMETER SELECT** chart on the JV-1010's top panel.

MEMO

To exit from the Edit mode without carrying out a Factory Reset, follow the same procedure as in step 2.

Listening to Demo Songs (Demo Play)

The JV-1010 comes with four demonstration songs.

Here's how to start Demo Play, and listen to the outstanding sounds of the JV-1010.

Song Name	Composer/Copyright
All In Good Time	Scott Wilkie © 1999 Scott Wilkie Media (ASCAP)
Guitars Forever	Gundy Keller © 1999 Gundy Keller / A-TOWN recordings
Rude99	Hans-Joerg Scheffler © 1999 Hans Scheffler
Overtime	Hans-Joerg Scheffler © 1999 Hans Scheffler

NOTE

All rights reserved. Unauthorized use of this material for purposes other than private, personal enjoyment is a violation of applicable laws.

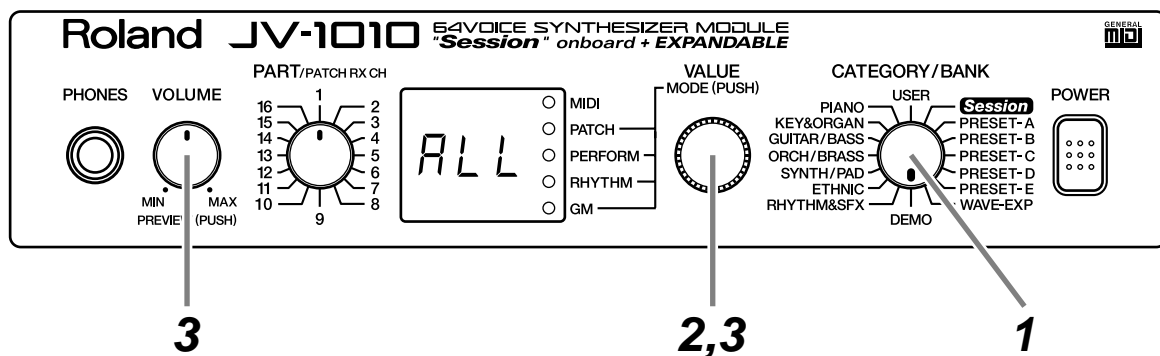

1 Turn the CATEGORY/BANK knob to choose **DEMO**.

ALL flashes on the display.

2 Turn the VALUE knob to choose the song you want to hear.

You can choose **ALL**, **d-1**, **d-2**, **d-3**, or **d-4**.

ALL: the songs will playback successively, beginning from the first.

d-1: All In Good Time

d-2: Guitars Forever

d-3: Rude99

d-4: Overtime

3 Press the VALUE knob or the VOLUME knob.

The display shows **PLY** and Demo Play starts.

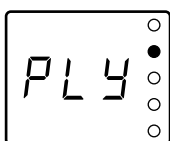

After a demo song has played all the way to the end, the unit automatically returns to the start of the song and playback is repeated. To end Demo Play partway through a song, press the VALUE knob or the VOLUME knob, or turn the CATEGORY/BANK knob.

NOTE

MIDI messages received from external instruments are ignored while the Demo Play screen is displayed.

NOTE

No data for the music that is played will be output from MIDI OUT.

■ Composer Profiles

Scott Wilkie

Scott Wilkie is a contemporary jazz recording artist, based in southern California. He tours frequently with his own band, and also appears as an artist for Roland in the U.S., Japan, Europe and South America. His debut solo album, *Boundless*, was released worldwide in 1999 on Narada/Virgin Records. You can find him on-line at www.scottwilkie.com.

Gundy Keller

Gundy Keller, a Germany-based guitarist, songwriter and producer, has been an international demonstrator for Roland since 1986. Gundy focuses mainly on the GR synthesizers and the V-Guitar, for international music conventions as well as recording sessions requesting completely unusual guitar sounds. Besides creating his own production company, he's the founder and director of Rocksound Music School, a private institute for music instruction. Check out some of his other work on the Roland VG-8 Demo CD, or the Roland GR-30 Video.

Hans-Joerg Scheffler

Born and raised in the Ruhr valley, the biggest industrial area in Germany, Hans's attraction to noise and rhythm came naturally.

Today he runs his own company, DIGITAL AUDIO DESIGN, which produces sampling CDs and CD ROMs.

He works for Roland as a pro audio product specialist, as a sound designer for expansion boards, and as a composer of demo songs. He has released several CDs that use the Roland RSS system.

Soundclips of his work can be downloaded at: <http://www.united-sound.com/usmaster/cell2downde.htm>

Choosing and Playing Patches

The JV-1010 comes with a large number of onboard sounds. On the JV-1010, the sounds used for an ordinary performance are called **Patches**.

With the JV-1010, you can use seven groups—User, Preset A through E, and Session—and when a Wave Expansion Board (separately available) is installed, you can also use the Wave Expansion Board's onboard patches.

USER

There are 128 patches stored in memory, which you can overwrite with patches you create yourself.

PRESET-A-C, E

There are 512 patches stored in memory, which cannot be overwritten.

PRESET-D (GM [General MIDI])

These are patches for the General MIDI System, which is designed to standardize the specifications for MIDI functions for all manufacturers and models. There are 128 patches stored in memory, which cannot be overwritten.

Session

Already onboard is the data from the SR-JV80-09 Wave Expansion Board, which offers a selection of 255 patches, which cannot be overwritten.

WAVE-EXP (Wave Expansion Board installed in the slot)

Patches are stored in memory on the separately available Wave Expansion Board, and cannot be overwritten.



When using software for external MIDI devices, tone editors, and the like, you can transmit System Exclusive messages to rewrite USER content.



You can't choose a **WAVE-EXP** patch unless a Wave Expansion Board is installed in the slot EXP-B. When no Wave Expansion Board is installed, - - - appears on the display.

Auditioning Patches (Phrase Preview)

On the JV-1010, you can check out patches easily, since phrases are provided for each type of patch. Thanks to this, you don't need to have a MIDI keyboard or sequencer connected.

In this section, we'll listen to patch sounds in the Patch mode.

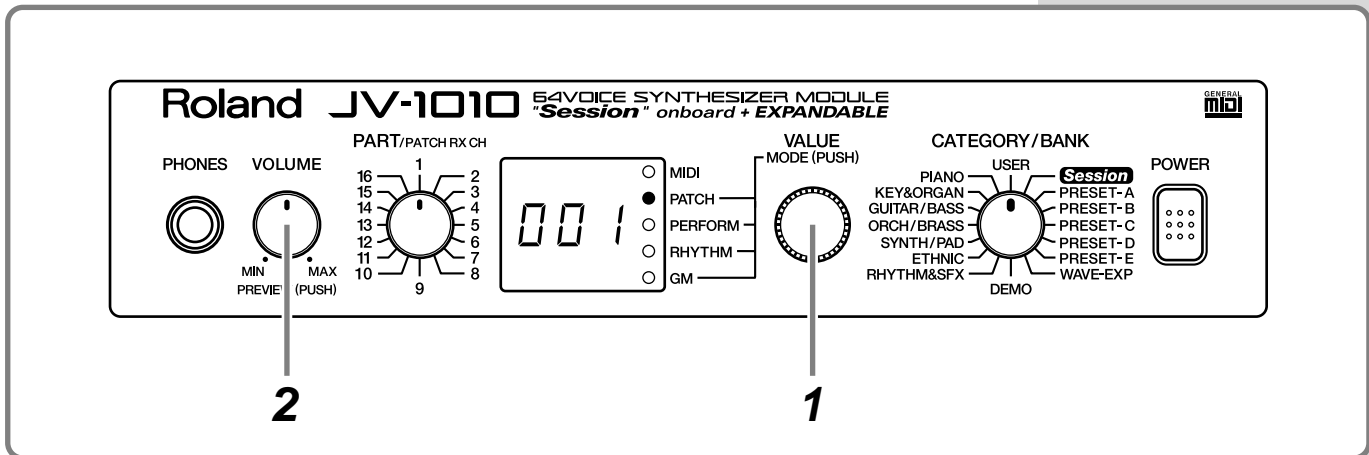

1 Press the VALUE knob to choose the Patch mode (**PATCH**).

Pressing the VALUE knob makes the mode change sequentially. Press the knob several times, until the PATCH indicator lights up.

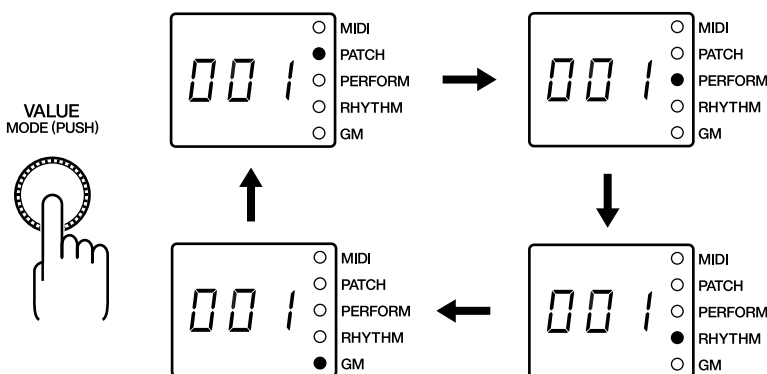

2 Holding down the VOLUME knob, the sound for the currently selected patch is played.

MEMO

Right after returning settings to their factory defaults, the first patch of the currently selected Category and Bank (CATEGORY/BANK) plays.

NOTE

Some patches may not be sounded in a suitable range.

Playing Notes from a MIDI Keyboard

The JV-1010 receives and plays MIDI data from other instruments. When doing this, the transmitting instrument (the MIDI keyboard or the like) and the JV-1010 must be set to the same MIDI channel.

Here we'll play sounds with both channels set to 1.

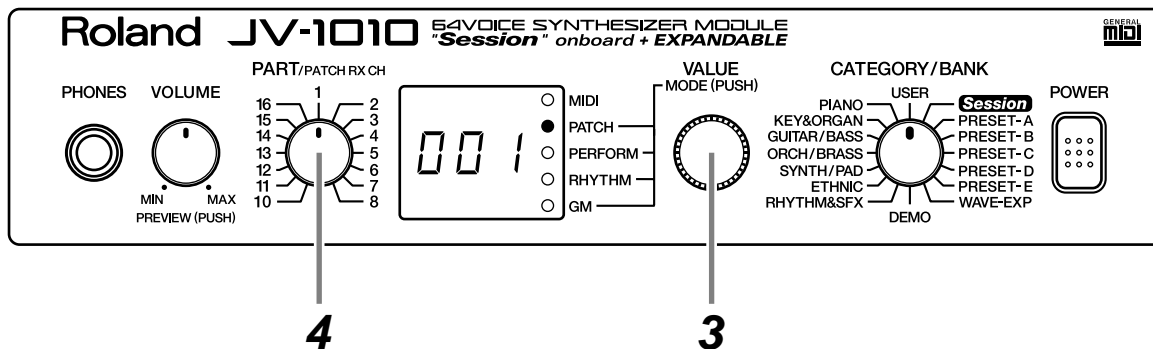

1 Connect a MIDI keyboard to the JV-1010 (p. 18).

2 Set the transmit channel for the MIDI keyboard (the transmitting instrument) to 1.

For information on how to make the settings, refer to the owner's manual for the MIDI keyboard.

3 Press the VALUE knob to choose the Patch mode (**PATCH**).

Pressing the VALUE knob makes the mode change sequentially. Press the knob several times, until the PATCH indicator lights up.

4 Turn the PART knob and choose 1.

Here, 1 becomes the JV-1010's receive channel.

5 Finger some keys on the MIDI keyboard to play a few notes.

When MIDI data is received, the MIDI indicator lights up.

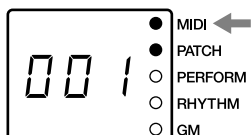

Choosing Patches

When you've selected the Patch mode or the Performance mode, after changing the Category and Bank with the CATEGORY/BANK knob, you can choose a patch by turning the VALUE knob.

You can use either of two methods to choose a patch: choosing **by bank** (display with white text) or choosing **by category** (display in blue text).

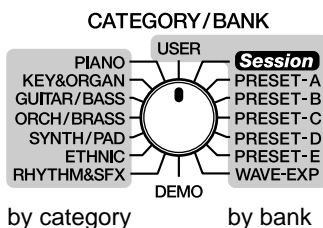

NOTE

You can't choose a **WAVE-EXP** patch unless a Wave Expansion Board is installed in the slot EXP-B. When no Wave Expansion Board is installed, - - - appears on the display.

■ Choosing Patches by Bank

In this section, let's choose **No. 108 Flute** from **USER** (the User group).

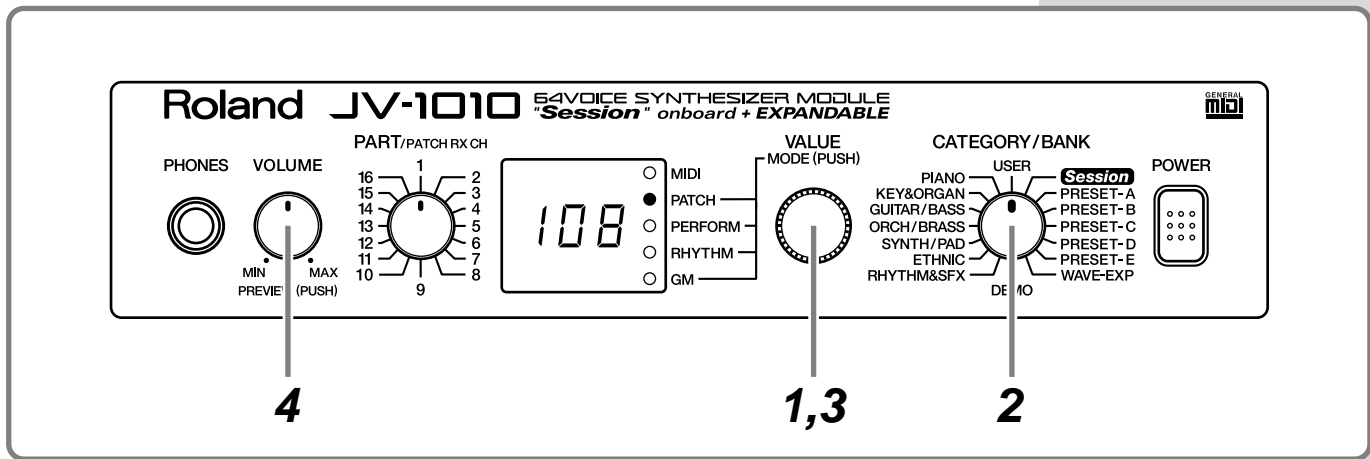

- 1 Press the VALUE knob to choose the Patch mode (**PATCH**).
Pressing the VALUE knob makes the mode change sequentially. Press the knob several times, until the PATCH indicator lights up.
- 2 Turn the CATEGORY/BANK knob to choose **USER**.
- 3 Turn the VALUE knob and choose **108**.
- 4 You can listen to the selected patch sound (USER No. 108 Flute) by holding down the VOLUME knob.

At this time, the currently selected preset bank **USr** (USER) and the patch number **108** appear in alternation on the display.

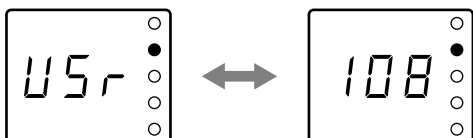

MEMO

Turning the VALUE knob rapidly makes the value change in large increments.

MEMO

For more information about the onboard patches, take a look at "Patch List" (p. 54).

Choosing and Playing Patches

■ Choosing Patches by Category

Here, let's choose **No. 008 Bright Piano** from **PIANO** (the Piano category).

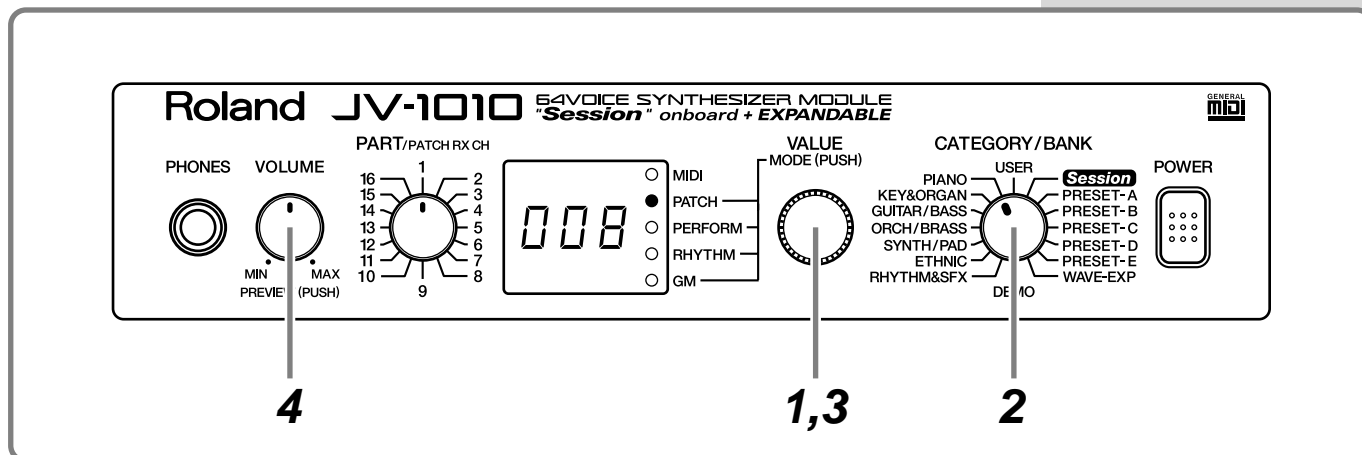

1 Press the VALUE knob to choose the Patch mode (**PATCH**).

Pressing the VALUE knob makes the mode change sequentially. Press the knob several times, until the PATCH indicator lights up.

2 Turn the CATEGORY/BANK knob to choose **PIANO**.

3 Turn the VALUE knob to choose **008**.

4 You can listen to the selected patch sound (PIANO No. 008 Bright Piano) by holding down the VOLUME knob.

At this time, the currently selected bank **PrA** (PRESET-A) and the patch number **002** appear in alternation on the display.

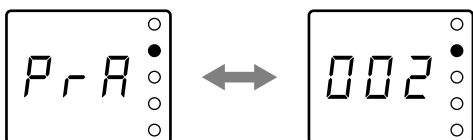

When you release the VOLUME knob, the display shows the patch number **008** of the category group **PIANO**.

NOTE

The patches you can choose by category are Preset A, B, C, D, and E, and Session (XP-A) patches. The sounds and categories of User and WAVE-EXP (XP-B) patches vary, so you can't choose these patches by category.

MEMO

Turning the VALUE knob rapidly makes the value change in large increments. Also, turning the VALUE knob while pressing it in jumps you to the value at the start of each category, in the currently selected category group. The start values for by-category patches are shown with a dot at the end of the number on the display.



MEMO

For more information about the by-category patches, take a look at "Patch Category List" (p. 58).

Playing Percussion Sounds

The JV-1010 has **Rhythm Sets** that contain a variety of percussion instruments and special effects sounds.

With the JV-1010, you can use seven groups—User, Preset A through E, and Session—and when a Wave Expansion Board (separately available) is installed, you can also use the Wave Expansion Board's onboard rhythm sets.

USER

There are 2 rhythm sets stored in memory, which you can overwrite with patches you create yourself.

PRESET-A-C, E

There are 8 rhythm sets stored in memory, which cannot be overwritten.

PRESET-D (GM [General MIDI])

These are rhythm sets for the General MIDI System, which is designed to standardize the specifications for MIDI functions for all manufacturers and models. There are 2 rhythm sets stored in memory, which cannot be overwritten.

Session

Already onboard is the data from the SR-JV80-09 Wave Expansion Board, which offers a selection of 8 rhythm sets, which cannot be overwritten.

WAVE-EXP (Wave Expansion Board installed in the slot)

Patches are stored in memory on the separately available Wave Expansion Board, and cannot be overwritten.



When using software for external MIDI devices, tone editors, and the like, you can transmit System Exclusive messages to rewrite USER content.



You can't choose a **WAVE-EXP** patch unless a Wave Expansion Board is installed in the slot EXP-B. When no Wave Expansion Board is installed, - - - appears on the display.

Choosing and Playing Patches

To play rhythm sets using a MIDI keyboard, set the MIDI transmit channel for the MIDI keyboard to **10**.

Here's how you can play percussion instruments using rhythm sets:

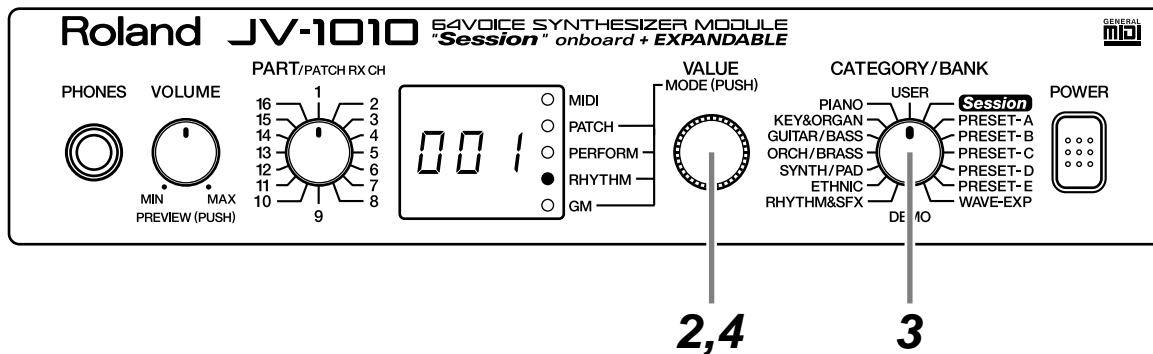

- 1 Set the transmit channel for the MIDI keyboard (the transmitting instrument) to **10**.

For information on how to make the settings, refer to the owner's manual for the MIDI keyboard (the transmitting instrument).

- 2 Press the VALUE knob and choose the Rhythm Set mode (**RHYTHM**).

Pressing the VALUE knob makes the mode change sequentially. Press the knob several times until the RHYTHM indicator lights up.

- 3 Turn the CATEGORY/BANK knob and choose a bank. Make your selection from the text displayed in white.

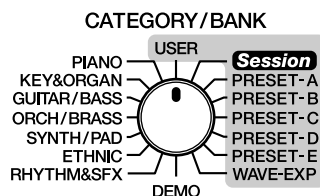

- 4 Turn the VALUE knob and choose a rhythm set.

- 5 Finger some keys on the MIDI keyboard to play a few notes.

A wide variety of percussion sounds are played, depending on the keys you finger.

When MIDI data is received, the MIDI indicator lights up.



You can't choose a **WAVE-EXP** patch unless a Wave Expansion Board is installed in the slot EXP-B. When no Wave Expansion Board is installed, --- appears on the display.



When you've selected the Rhythm Set mode, the display shows the settings for Part 10, no matter what setting the PART knob is at.



For more information about the onboard rhythm sets, take a look at "Rhythm Set List" (p. 64).

Using the JV-1010 as the GM Sound Module

The JV-1010 features a **GM mode**—a convenient way to play back or create GM score data (music files for GM sound module). You're able to play back commercial GM score data releases and even modify various parameter settings for enhanced musical expression.

Entering GM Mode

Use GM mode to place the JV-1010's sound source in GM System compatible mode. Basically GM mode is similar to a special kind of Performance in which a GM System Rhythm Set is assigned to Part 10, and GM System Patches are assigned to other Parts.

MEMO

For more information about the performance, please refer to “**Performing Multiple Parts (Performance Mode)**” (p. 42).

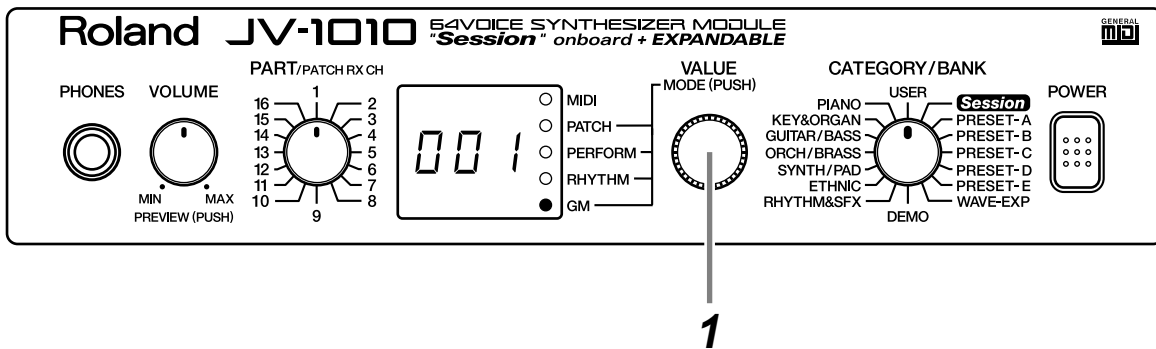

1

Press the VALUE knob to switch to the GM mode (**GM**).

Pressing the VALUE knob makes the mode change sequentially. Press the knob several times, until the GM indicator lights up.

When you switch to the GM mode, the sound generator is initialized with basic settings that allow it to conform with the General MIDI System.

Each time you enter GM mode, the GM Drum Set is assigned to Part 10, and Piano 1 is assigned to other Parts. You can also select other GM Patches and GM Drum Sets for each Part to match the performance.

MEMO

If you want to preserve the GM mode settings, save the settings to an external MIDI device by transmitting them as MIDI messages. For further details, see “**Transmitting Settings to an External MIDI Device (Data Transfer)**” (p. 48).

NOTE

In GM mode, “- - -” appears in the display when a parameter that cannot be set is selected.

Changing Sounds from an External MIDI Device

You can change patches, performances, and rhythm sets by transmitting Bank Select messages (Controller numbers 0 and 32) and Program Change messages to the JV-1010 from an external MIDI device. That is, selecting sounds on an external MIDI keyboard transmits messages corresponding to the specified sounds to the JV-1010, thus changing the patch or the like on the JV-1010.

■ Note on Using an External MIDI Device to Switch Sounds

If an external MIDI device transmits a Bank Select message that is outside the range that the JV-1010 considers as being valid, it is ignored—only the Program Change message is accepted.

When a JV/XP Series MIDI device is connected to the JV-1010, selecting a Wave Expansion C (XP-C) or later bank or sound may result in a switch to a number other than the intended number, so use numbers within the allowable reception range.

For more on which Bank Select messages can be received, refer to “MIDI Implementation” (p. 68).

If the Program Numbers on your external MIDI device are referenced as values from 0 to 127, find the appropriate number by subtracting 1 from the number in this unit’s correspondence chart. The numbers are displayed in decimal format.



On the JV-1010, when just a Program Change message is received without receiving a Bank Select message, only sounds within a group (such as PRESET-A or USER) are changed.

Changing Patches

The JV-1010 can change patches (including the patches for various parts in a performance) in response to the MIDI data it receives.

Here, we’ll set the transmit channel on the external MIDI device and the receive channel on the JV-1010 to 1, then transmit a MIDI message from the external MIDI device to change the patch on the JV-1010 to **No. 010 Hip Bass** in **PRESET-B**.

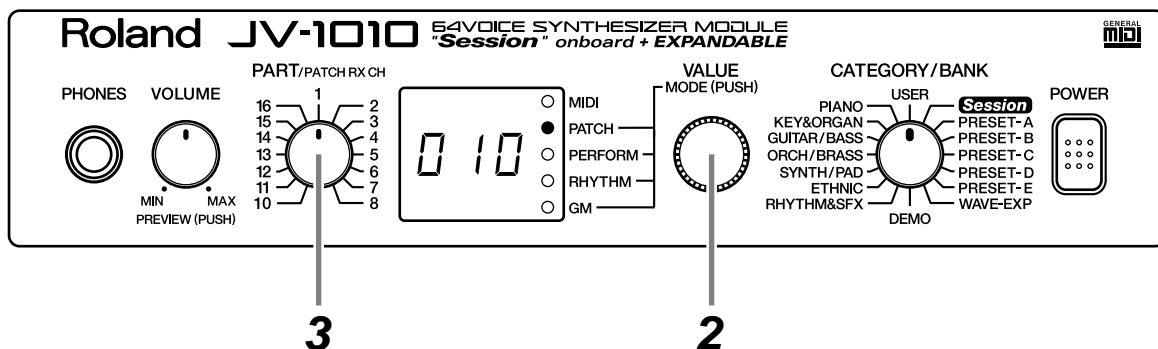

1

Set the transmit channel on the external MIDI device to 1.

For information on how to make the settings, refer to the owner’s manual for the external instrument (the transmitting instrument).

2 Press the VALUE knob to choose the Patch mode (**PATCH**).
Pressing the VALUE knob makes the mode change sequentially. Press the knob several times, until the PATCH indicator lights up.

3 Turn the PART knob and choose **1**.
Here, **1** becomes the JV-1010's receive channel.

4 Transmit a Bank Select MSB (Controller Number 0) value of **81** from the external MIDI device to the JV-1010

5 Transmit a Bank Select LSB (Controller Number 32) value of **1** from the external MIDI device to the JV-1010.

6 Transmit a Program Change **10** from the external MIDI device to the JV-1010.

The display on the JV-1010 shows **010** to indicate the switch to the **PRESET-B** patch **No. 010 Hip Bass**.

The correspondences between MIDI messages transmitted from external MIDI devices and Patch Numbers are as shown below.

Patch Group	Patch Number	Bank Select MSB	Bank Select LSB	Program Number
USER	1-128	80	0	1-128
PRESET-A	1-128	81	0	1-128
PRESET-B	1-128	81	1	1-128
PRESET-C	1-128	81	2	1-128
PRESET-D	1-128	81	3	1-128
PRESET-E	1-128	81	4	1-128
Session	1-128	84	0	1-128
Session	129-255	84	1	1-127
WAVE-EXP	1-128	84	2	1-128
WAVE-EXP	129-256	84	3	1-128

NOTE

Be sure to set the transmit channel for the external MIDI device and the receive channel for the JV-1010 to the same channel.

NOTE

On the JV-1010, when just a Program Change message is received without receiving a Bank Select message, only patches and rhythm sets within the same group are changed.

Changing a Performance

When changing a performance, set the transmit channel of the external MIDI device and the Performance Control Channel (Perform Ctrl CH) of the JV-1010 to the same channel, then transmit the Bank Select and Program Change messages.

Now let's set the transmit channel on the external MIDI device and the Performance Control Channel (Perform Ctrl CH) on the JV-1010 to the same channel and try changing the performance.

MEMO

For more information about the performance, please refer to "Performing Multiple Parts (Performance Mode)" (p. 42).

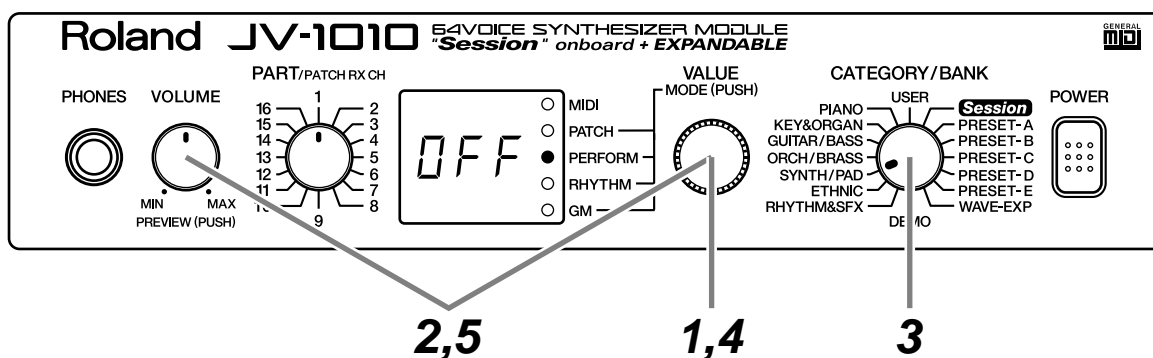

- 1 Press the VALUE knob and choose the Performance mode (**PERFORM**).

Pressing the VALUE knob makes the mode change sequentially. Press the knob several times until the PERFORM indicator lights up.

- 2 While holding down the VOLUME knob, press the VALUE knob.

Switch to the Edit mode.

- 3 Turn the CATEGORY/BANK knob to choose **SYNTH/PAD** (**Perform Ctrl CH**).

- 4 Turn the VALUE knob and choose the channel.

A value of from **001** to **016**, or **OFF** flashes in the display.

- 5 While holding down the VOLUME knob, press the VALUE knob.

The JV-1010 exits Edit mode.

MEMO

When you first take the unit out of the box, the setting for the Performance Control Channel is at **OFF**.

6 Set the transmit channel on the external MIDI device to the same value that you selected for the Performance Control Channel (Perform Ctrl CH) in step 4.

For information on how to make the settings, refer to the owner's manual for the MIDI keyboard (the transmitting instrument).

7 Transmit a Bank Select MSB (Controller Number 0) value (refer to the following table) from the external MIDI device to the JV-1010.

8 Transmit a Bank Select LSB (Controller Number 32) value (refer to the following table) from the external MIDI device to the JV-1010.

9 Transmit a Program Change message from the external MIDI device to the JV-1010 (refer to the following table).

The correspondences between MIDI messages transmitted from external MIDI devices and Performance Numbers are as shown below.

Performance Group	Performance Number	Bank Select MSB	Bank Select LSB	Program Number
USER	1-32	80	0	1-32
PRESET-A	1-32	81	0	1-32
PRESET-B	1-32	81	1	1-32

NOTE

When changing patches or rhythm sets in various parts of a performance, set the transmit channel of the external device and the receive channel of the part to the same channel. Note that when the Performance Control Channel and the receive channel for the part are the same, the setting for the Performance Control Channel takes priority, and the performance is switched.

Changing a Rhythm Set

When changing a rhythm set, set the transmit channel of the external MIDI device and the receive channel of part **10** of the performance on the JV-1010 to the same channel, then transmit the Bank Select and Program Change messages.

Now let's try changing the rhythm set from the external MIDI device.

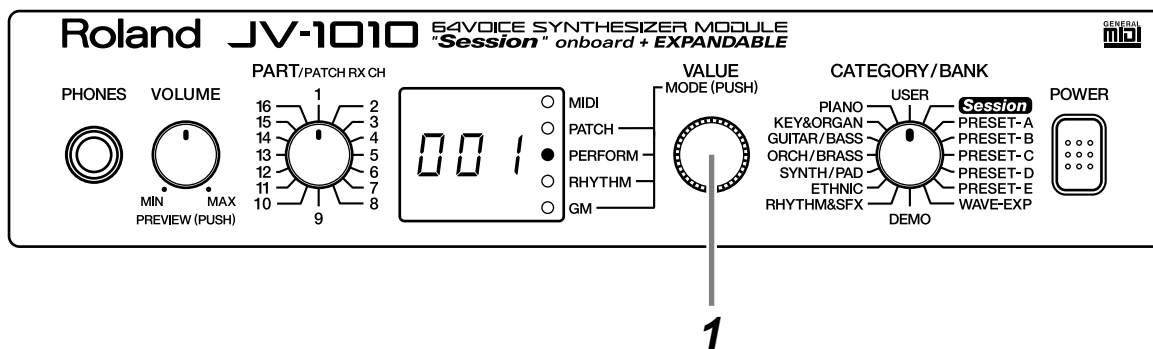

- 1 Press the VALUE knob and choose the Performance mode (**PERFORM**) or the Rhythm Set mode (**RHYTHM**).

Pressing the VALUE knob makes the mode change sequentially. Press the knob several times until the PERFORM or RHYTHM indicator lights up.

- 2 Set the transmit channel on the external MIDI device to **10**.

For information on how to make the settings, refer to the owner's manual for the MIDI keyboard (the transmitting instrument).

- 3 Transmit a Bank Select MSB (Controller Number 0) value (refer to the following table) from the external MIDI device to the JV-1010.

- 4 Transmit a Bank Select LSB (Controller Number 32) value (refer to the following table) from the external MIDI device to the JV-1010.

MEMO

When you first take the unit out of the box, the receive-channel setting for Part 10 is 10. For more information about part receive-channel settings, check out **Reference Manual** that is on the included CD-ROM.

5

Transmit a Program Change message from the external MIDI device to the JV-1010 (refer to the following table).

The correspondences between MIDI messages transmitted from external MIDI devices and Rhythm Set Numbers are as shown below.

Rhythm Set Group	Rhythm Set Number	Bank Select		Program Number
		MSB	LSB	
USER	1, 2	80	0	1, 2
PRESET-A	1, 2	81	0	1, 2
PRESET-B	1, 2	81	1	1, 2
PRESET-C	1, 2	81	2	1, 2
PRESET-D	1, 2	81	3	1, 2
PRESET-E	1, 2	81	4	1, 2
Session	1-8	84	0	1-8
WAVE-EXP	1-128	84	2	1-128
WAVE-EXP	129-256	84	3	1-128

Trying Out Desktop Music

If you are running music software on your computer, you can use the computer to control the operation of the JV-1010. Of course, this allows you to play back and create song data, switch sounds automatically, and create sounds from the screen. This type of system is known as **DTM (desktop music)**. The actual DTM functions available vary greatly with the application used. Therefore, it is very important to select software that matches your particular aims.

Connecting to a Computer

Two Ways to Connect

There are two methods that can be used to connect the JV-1010 to a computer, **connecting to the COMPUTER connector** and **connecting with MIDI connectors**.

When connecting to the COMPUTER connector, a computer cable is used to connect the JV-1010 to your computer's serial port (RS-232C).

When using MIDI connectors to make the connection, a MIDI interface (such as Roland's Super MPU64) is required. In this case, the MIDI interface is connected to the computer, and a MIDI cable is used to connect the MIDI connectors of the MIDI interface to the JV-1010's MIDI connectors.

Use the connection method that best suits your operating environment to connect the JV-1010 to your computer.

If connecting using the MIDI connectors, please read the related information starting on p. 41.

■ Connecting to the COMPUTER Connector

1

Switch off the power to the JV-1010, the computer, and any connected equipment.

NOTE

To prevent malfunction and/or damage to speakers or other devices, always turn down the volume, and turn off the power on all devices before making any connections.

2 Set the COMPUTER switch on the JV-1010's rear panel to match the type of computer to be connected as described below.

For Apple Macintosh computers: **Mac**
 For PCs: **PC-2**

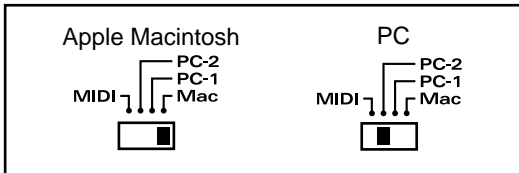

The connection method described in the following step varies according to the type of computer; read the applicable section (**3a** or **3b**).

3a For PCs

When using a PC, connect the computer cable to the serial port (RS-232C connector) found on the computer's rear panel.

Computer cable (sold separately): RSC-15AT

This cable has a nine-pin connector. If a cable with 25-pin connectors is required, refer to the "Computer Cable Wiring Diagrams" (p. 90) and obtain the appropriate cable.

3b For Apple Macintosh Computers

When connecting to a Macintosh computer, connect the computer cable to either the modem port or the printer port on the computer's rear panel.

Computer cable (sold separately): RSC-15APL

NOTE

Before changing the COMPUTER switch setting, first switch off the power to the JV-1010.

NOTE

As this setting determines the rate at which data is transferred between the computer and the JV-1010 (baud rate), it is necessary that both the computer and JV-1010 settings match. This setting determines the baud rate for the JV-1010. When setting your computer, it may be necessary to make settings in the software as well. If you are using Windows, the driver setting may differ from that described in Step 2. In such cases, carefully read the manual included with the driver, and then make the necessary settings.

MEMO

The PC-2 baud rate is 38.4 (kbit/sec), and the PC-1 baud rate is 31.25 (kbit/sec).

Trying Out Desktop Music

4

Connect the other end of the computer cable to the JV-1010's COMPUTER connector.

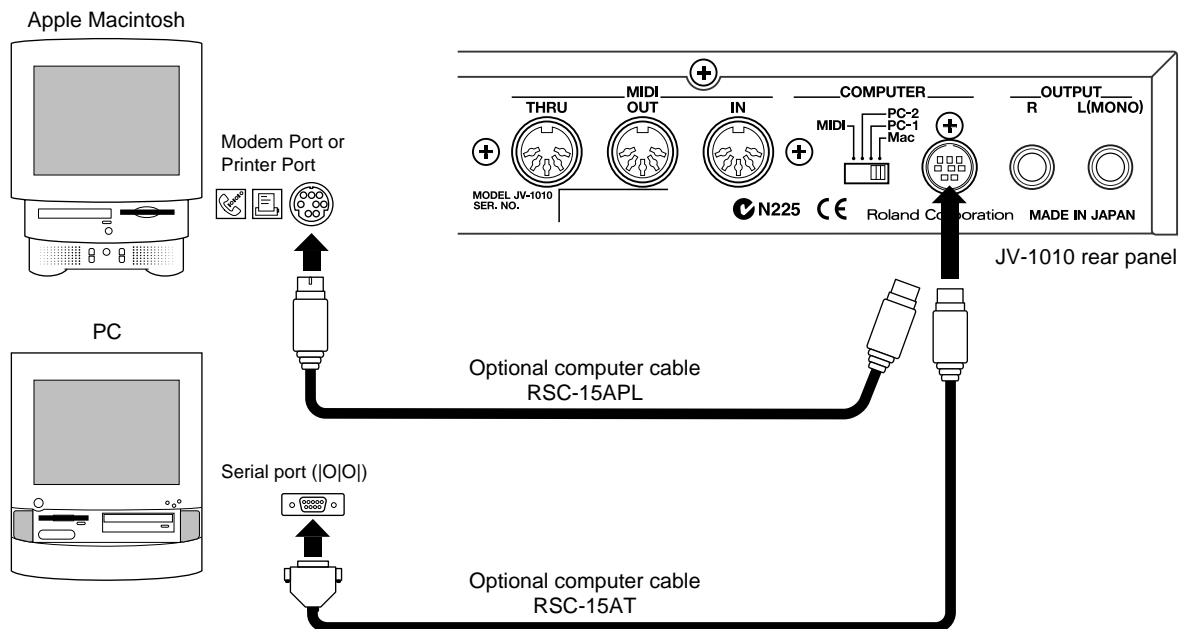

NOTE

Playing back sounds from the JV-1010 requires that the AC adaptor be plugged in and connection of either audio cables or headphones. If these connections have not yet been made, please refer to **“Making the Connections”** (p. 18). If the connections are complete, please see **“Switching On the Power”** (p. 20).

■ Connecting with MIDI Connectors

If you have a MIDI interface (such as Roland's Super MPU64) connected to your computer or are connecting to a MIDI interface adaptor, you can then connect using the MIDI connectors.

MEMO

For instructions on connecting to a computer using a MIDI interface, refer to the owner's manual that was supplied with the MIDI interface.

NOTE

To prevent malfunction and/or damage to speakers or other devices, always turn down the volume, and turn off the power on all devices before making any connections.

NOTE

Before changing the COMPUTER switch setting, first switch off the power to the JV-1010.

1 Switch off the power to the JV-1010, the computer, and any connected equipment.

2 Set the COMPUTER switch on the JV-1010's rear panel to **MIDI**.

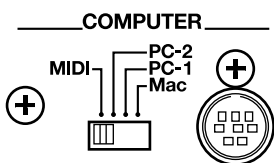

3 Use a MIDI cable to connect the MIDI OUT connector of the MIDI interface with the JV-1010's MIDI IN connector.

4 Use a MIDI cable to connect the MIDI IN connector of the MIDI interface with the JV-1010's MIDI OUT connector.

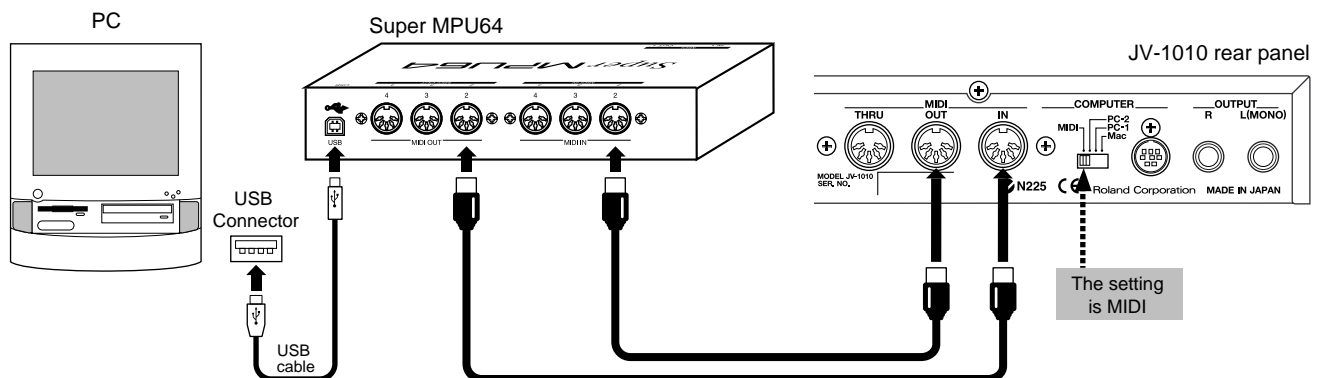
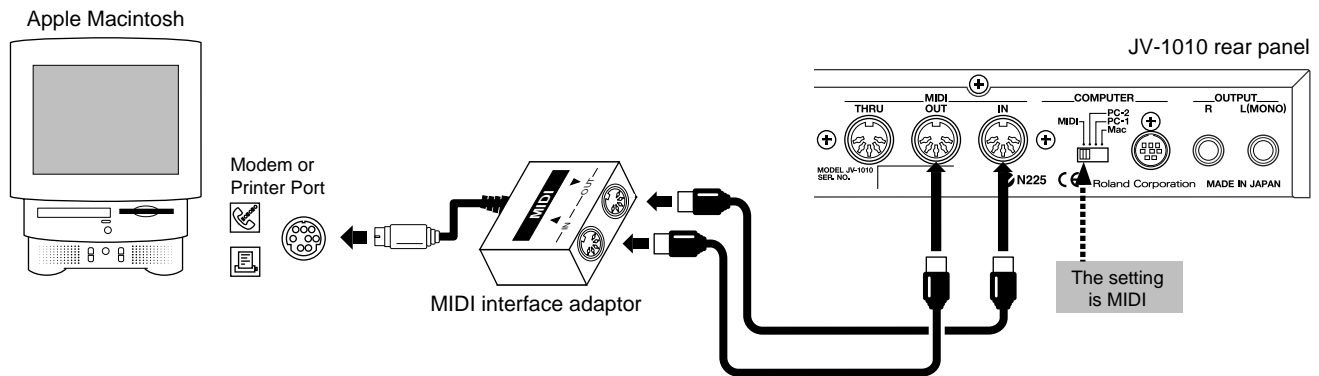

Performing Multiple Parts (Performance Mode)

A group of sixteen parts to which fifteen patches and one rhythm set are assigned (fixed at Part 10) is collectively referred to as a **Performance**.

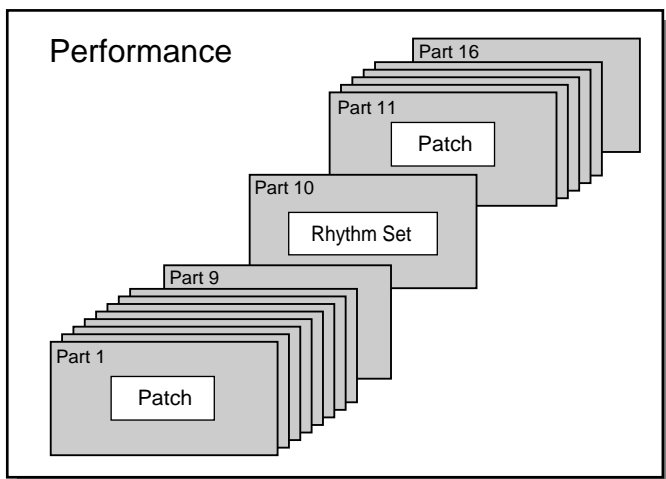

In a performance, you can assign each patch and rhythm set to a part, then combine these parts to enjoy an ensemble performance. One of the sixteen parts (Part 10) is reserved for the rhythm set, with patches assigned to the remaining fifteen parts.

In other words, using performances allows you to control sixteen separate sounds with one JV-1010.

A sound generator of this type which can control multiple sounds using one device is referred to as a **multitimbral sound generator**.

In the relationship between performances and parts, the performance is like an orchestra, parts are the performers, and patches and the rhythm set are the instruments.

Let's try selecting some parts and sounds, then play the multiple parts together as a performance.

As one example, select one of the sixteen parts, **PART 2**, then select the patch **No.008 Gtr Strings** in **GUITAR/BASS** (the GUITAR/BASS group).

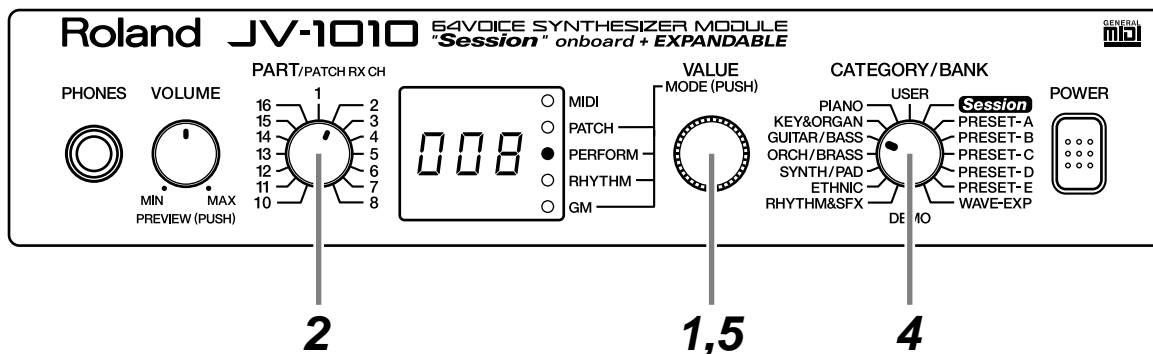

- 1 Press the VALUE knob to choose the Performance mode (**PERFORM**).

Pressing the VALUE knob makes the mode change sequentially. Press the knob several times, until the PERFORM indicator lights up.

- 2 Turn the PART knob and choose **2**.

- 3 Set the transmit channel of the external device (the transmitting device) to **2**.

For information on how to make the settings, refer to the owner's manual for the MIDI keyboard (the transmitting instrument).

- 4 Turn the CATEGORY/BANK knob to choose **GUITAR/BASS**.
Now, select the patch category.

- 5 Turn the VALUE knob to choose patch **008**.

Now, patch **No.008 Gtr Strings** in the **GUITAR/BASS** category is selected for **PART 2**.

- 6 Repeat Steps 2–5, using the same procedure to select other parts.

- 7 Using a sequencer or computer, play back the song.

For instructions on how to play back songs, refer to the owner's manual for the external device (the transmitting device).

NOTE

Always make sure that the number selected with the JV-1010's PART knob matches the transmit channel of the external device (the transmitting device). Additionally, remember that **PART 10** is used exclusively by the rhythm set.

NOTE

Turning off the JV-1010's power without saving the created data results in the loss of that data. Save any important data that you wish to preserve to an external MIDI device (p.

NOTE

The Performance Control Channel (Perform Ctrl CH) is preset at the factory to **OFF**; remember that patches are switched when program changes are recorded in a song. To release the Performance Control Channel (Perform Ctrl CH) **OFF** setting, set to something other than **OFF** (p. 49).

MEMO

For more information about the onboard patches, take a look at "**Performance List**" (p. 67).

Editing Using Only the JV-1010

Making Part Settings (PART)

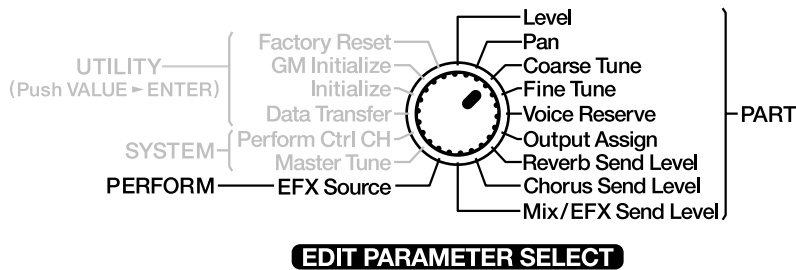

Now try changing the level setting (**Level**) for **PART 2** in Performance mode.

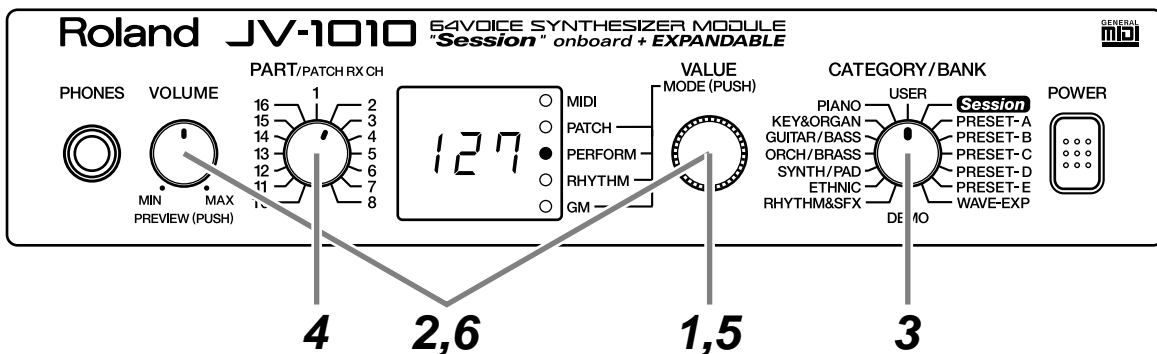

- 1 Press the VALUE knob to choose the Performance mode (**PERFORM**).
Pressing the VALUE knob makes the mode change sequentially. Press the knob several times, until the PERFORM indicator lights up.
- 2 While holding down the VOLUME knob, press the VALUE knob.
Switch to the Edit mode.
- 3 Turn the CATEGORY/BANK knob to choose **USER (Level)**.
- 4 Turn the PART knob and choose **2**.
In Edit mode, you can select **USER (Level)** with the CATEGORY/BANK knob to change the volume level setting for each part.

NOTE

When in the Patch mode, you can't enter the Edit mode.

MEMO

For more information about the CATEGORY/BANK knob's other functions in Edit mode, refer to the **EDIT PARAMETER SELECT** chart on the JV-1010's top panel.

5 Turn the VALUE knob to change the level. This can be set in the range **000–127**.

Pan, Coarse Tune, and other parameters can be set in the same way. For more detailed information about each parameter and its settings, refer to the **Reference Manual** that is on the included CD-ROM.

6 While holding down the VOLUME knob, press the VALUE knob.

The JV-1010 exits Edit mode.

NOTE

Turning off the JV-1010's power without saving the created data results in the loss of that data. Save any important data that you wish to preserve to an external MIDI device (p. 48).

Memory-Related Operations (UTILITY)

These operations include initialization of data such as the JV-1010 internal sound data, and transmission of settings to external devices.

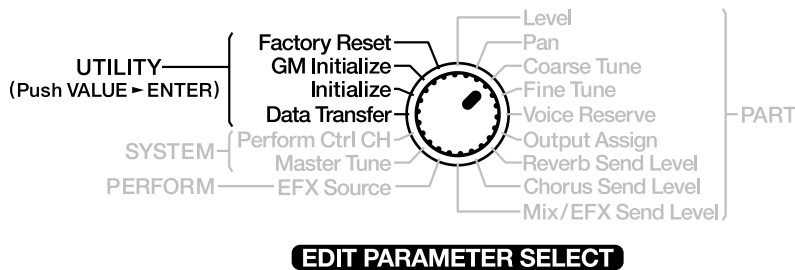

Restoring the Factory Settings (Factory Reset)

This operation restores all settings stored in the JV-1010 to their condition at the time the unit was shipped from the factory.

For more detailed information and instructions for this procedure, refer to the “Reset to Default Factory Settings (Factory Reset)” (p. 21).

■ Initializing GM Mode (GM Initialize)

Using a computer or sequencer connected to the JV-1010 to play music data bearing the GM logo requires the system be initialized for GM. Carrying out this initialization restores the basic GM settings.

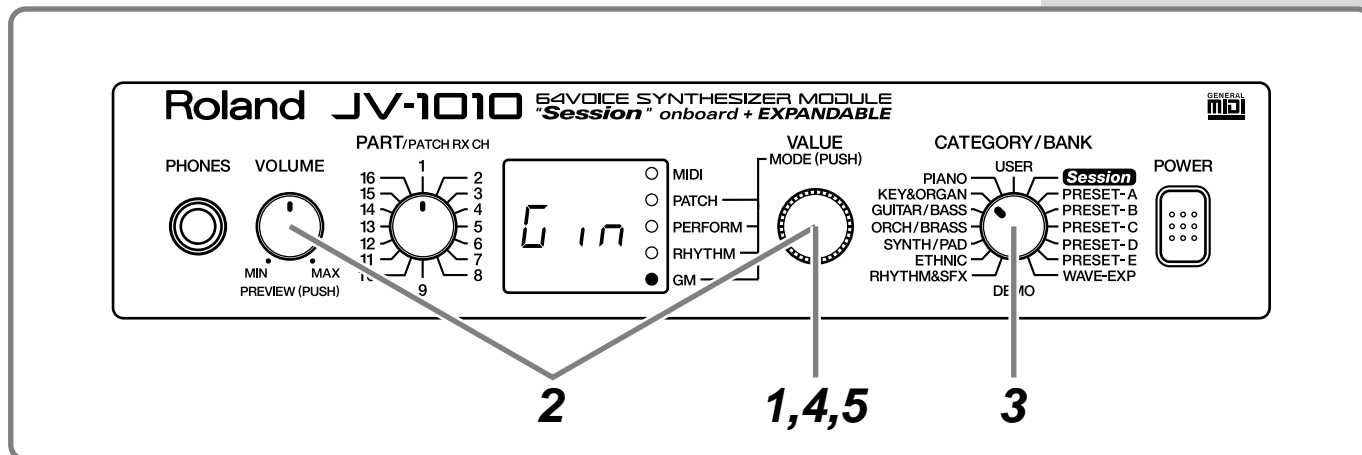

1 Press the VALUE knob to switch to the GM mode (GM).

Pressing the VALUE knob makes the mode change sequentially. Press the knob several times, until the GM indicator lights up.

2 While holding down the VOLUME knob, press the VALUE knob.

Switch to the Edit mode.

3 Turn the CATEGORY/BANK knob to choose **KEY&ORGAN (GM Initialize)**.

Gin flashes on the display.

4 Press the VALUE knob.

Sur flashes in the display; this is a prompt for you to confirm whether or not you want to execute GM Initialize.

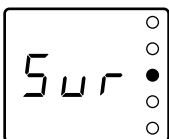

5 Press the VALUE knob.

GM Initialize is executed, and the JV-1010 exits Edit mode.

NOTE

The GM Initialize operation affects only GM mode data; no data stored in the user memory is initialized. If you want to restore all settings to their factory values, carry out Factory Reset (p. 21).

NOTE

When in the Patch mode, you can't enter the Edit mode.

MEMO

To exit Edit mode without executing GM Initialize, carry out the operation described in Step 2.

■ Initializing the Settings (Initialize)

This restores the currently selected performance and rhythm set to standard settings.

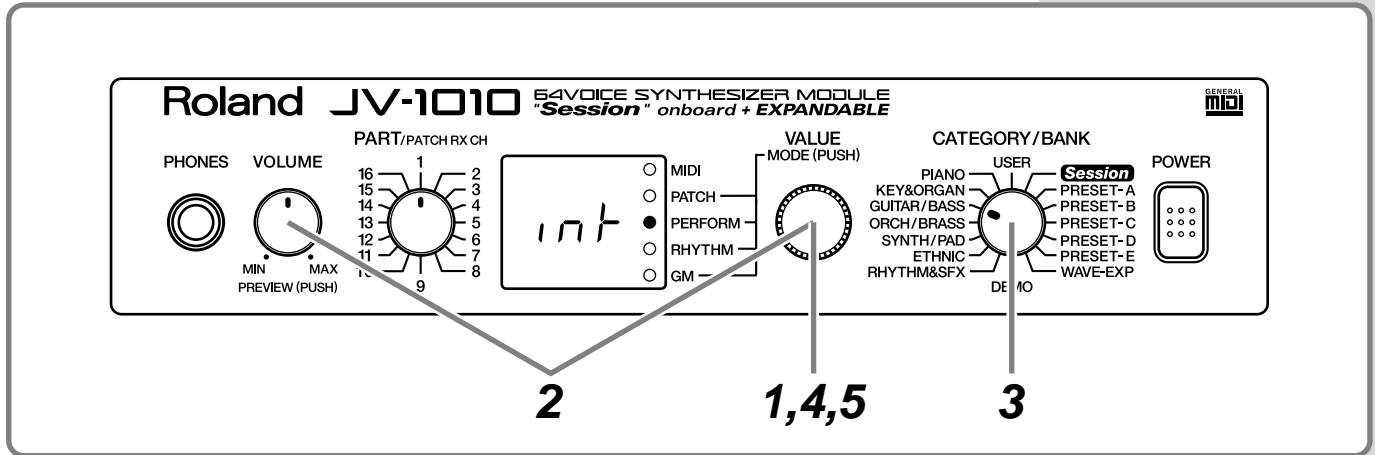

- 1 Press the VALUE knob and choose the Performance mode (**PERFORM**) or the Rhythm Set mode (**RHYTHM**).

Pressing the VALUE knob makes the mode change sequentially. Press the knob several times until the **PERFORM** or **RHYTHM** indicator lights up.

- 2 While holding down the VOLUME knob, press the VALUE knob.

Switch to the Edit mode.

- 3 Turn the CATEGORY/BANK knob to choose **GUITAR/BASS** (**Initialize**).

int flashes on the display.

- 4 Press the VALUE knob.

Sur flashes in the display; this is a prompt for you to confirm whether or not you want to execute Initialize.

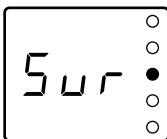

- 5 Press the VALUE knob.

Initialize is executed, and the JV-1010 exits Edit mode.

NOTE

The GM Initialize operation affects only the currently selected data; no data stored in the user memory is initialized. If you want to restore all settings to their factory values, carry out Factory Reset (p. 21).

NOTE

When in the Patch mode, you can't enter the Edit mode.

MEMO

To exit Edit mode without executing Initialize, carry out the operation described in Step 2.

■ Transmitting Settings to an External MIDI Device (Data Transfer)

This transmits Performance settings to an external MIDI device. This is useful for times such as when you want to save data on a MIDI instrument ahead of time. Connect the JV-1010's MIDI OUT connector to the MIDI IN connector of the external MIDI device with a MIDI cable. Then, after putting the external MIDI device in the mode where it is ready to receive data, start the procedure.



Patch parameters and system parameters are not included.

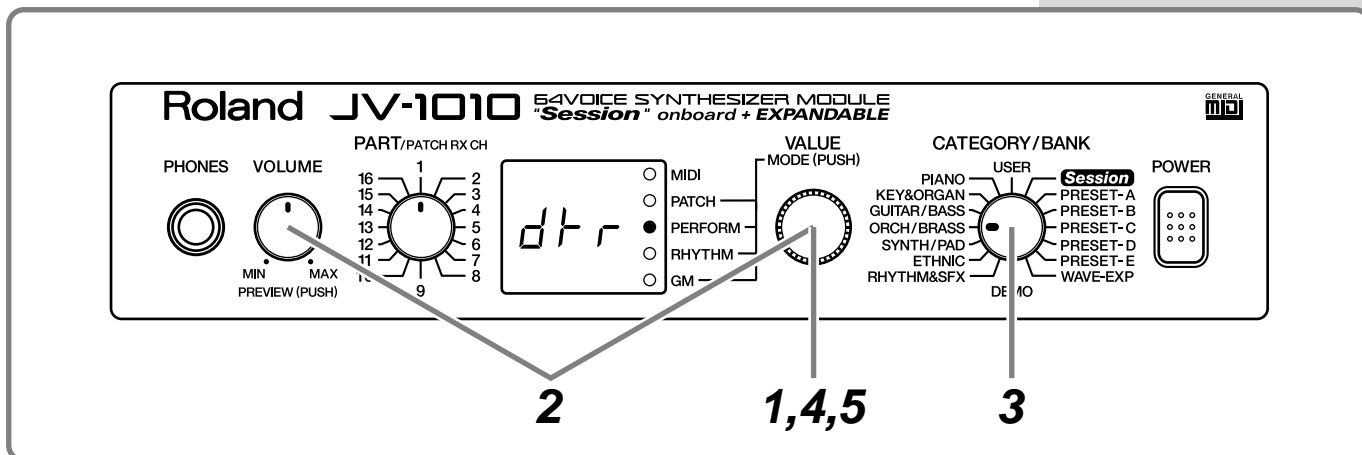

1 Press the VALUE knob to switch to a mode other than the Patch mode (**PATCH**), that is, to the **PERFORM**, **RHYTHM**, or **GM** mode.

2 While holding down the VOLUME knob, press the VALUE knob. Switch to the Edit mode.

3 Turn the CATEGORY/BANK knob to choose **ORCH/BRASS (Data Transfer)**.

dtr flashes on the display.

4 Press the VALUE knob.

Sur flashes on the display, prompting you to confirm that you want to carry out the Data Transfer.

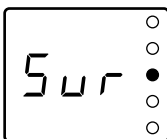

5 Press the VALUE knob.

The Data Transfer is performed, and the JV-1010 exits Edit mode.



When in the Patch mode, you can't enter the Edit mode.



Transmit GM mode settings while in GM mode. GM mode settings are lost when you switch to another mode.



To exit Edit mode without executing Data Transfer, carry out the operation described in Step 2.

Making System Settings (SYSTEM)

This sets the tuning and other parameters of the JV-1010's operating environment.

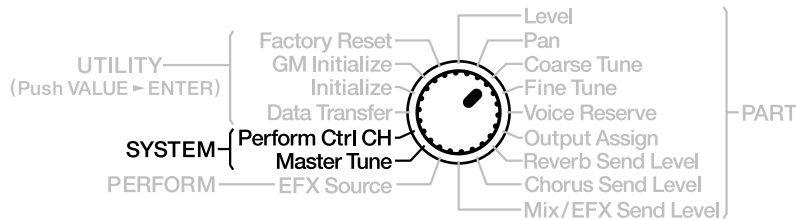

EDIT PARAMETER SELECT

■ Selecting the Receive Channel (Perform Ctrl CH)

This selects the receive channel when MIDI messages are used to switch performances.

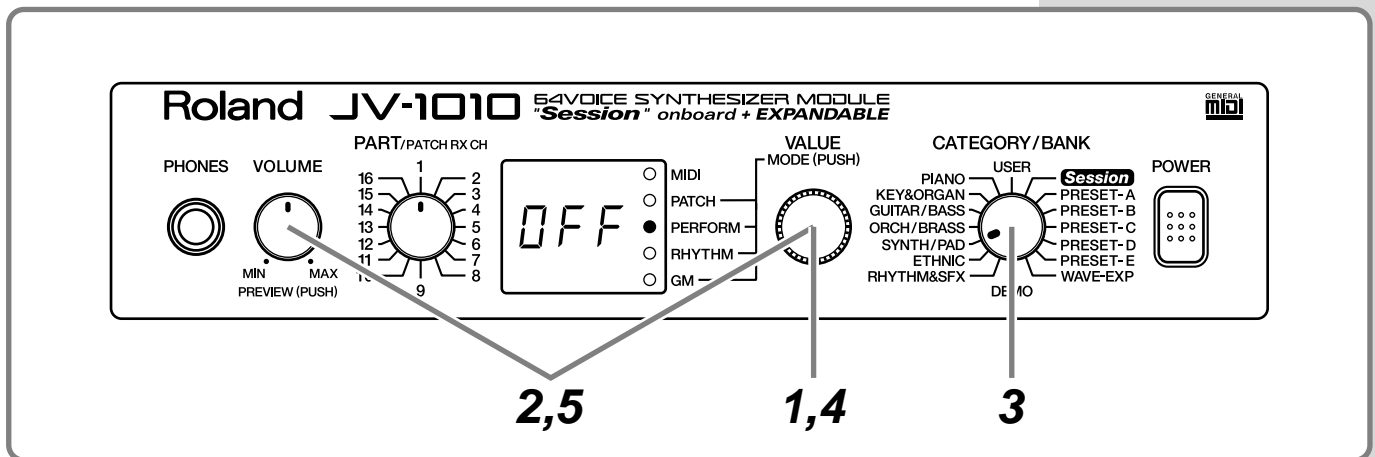

- 1** Press the VALUE knob and choose the Performance mode (**PERFORM**) or the Rhythm Set mode (**RHYTHM**).
Pressing the VALUE knob makes the mode change sequentially. Press the knob several times until the **PERFORM** or **RHYTHM** indicator lights up.
- 2** While holding down the VOLUME knob, press the VALUE knob. Switch to the Edit mode.
- 3** Turn the CATEGORY/BANK knob to choose **SYNTH/PAD** (**Perform Ctrl CH**).
- 4** Turn the VALUE knob to select the channel.
The value **001–016**, **OFF** flashes in the display.
- 5** While holding down the VOLUME knob, press the VALUE knob.
The JV-1010 exits Edit mode.

NOTE

When in the Patch mode, you can't enter the Edit mode.

MEMO

For more detailed information, refer to the **Reference Manual** that is on the included CD-ROM.

■ Tuning (Master Tune)

Allows the sound generator to be tuned. The value indicated is the frequency of Note Number 69 (the A4 key).

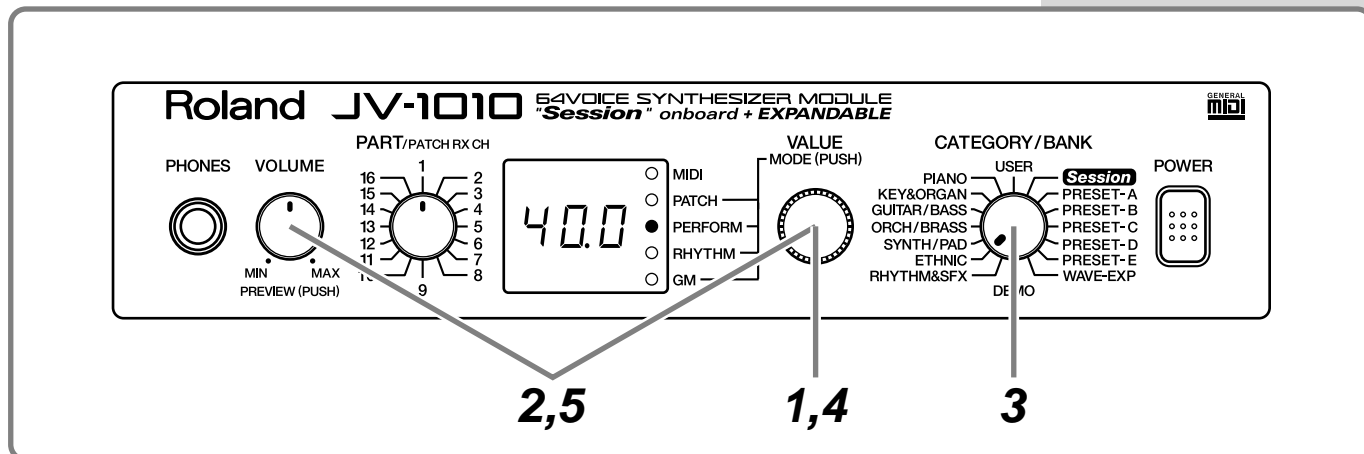

- 1 Press the VALUE knob to switch to a mode other than the Patch mode (**PATCH**), that is, to the **PERFORM**, **RHYTHM**, or **GM** mode.
- 2 While holding down the VOLUME knob, press the VALUE knob.
Switch to the Edit mode.
- 3 Turn the CATEGORY/BANK knob to choose **ETHNIC (Master Tune)**.
- 4 Turn the VALUE knob to adjust the tuning frequency.
The value **27.4–52.6** is indicated in the display.
- 5 While holding down the VOLUME knob, press the VALUE knob.
The JV-1010 exits Edit mode.

NOTE

When in the Patch mode, you can't enter the Edit mode.

NOTE

The hundreds place (4) is not displayed.

MEMO

For more detailed information, refer to the **Reference Manual** that is on the included CD-ROM.

JV-1010

64VOICE SYNTHESIZER MODULE
"Session" onboard + **EXPANDABLE**

Appendices

Troubleshooting

If no sound is produced, or if operation otherwise seems wrong, first check the following points. If after trying the following remedies, the unit still does not operate correctly, please contact your Roland dealer or the nearest Roland Service Center.

* Refer to the **“Error Messages”** (p. 53) if some kind of message is displayed on the screen during operation.

The power does not come on.

- Is the AC adaptor properly plugged onto the wall and the JV-1010?

No sound is produced.

- Is all other equipment, such as external amps and speakers, properly connected?
- Is the power to the JV-1010 and all connected external devices turned on?
- Is the JV-1010's VOLUME knob turned to **MIN**?
- Is the volume on any connected external devices turned down?
- Has the volume been lowered by volume/expression messages received from an external device?
- Have all connections been made properly?

When using the JV-1010 without a computer, please connect audio cables or headphones (p. 18).

If using the JV-1010 connected to a computer, use a computer cable or MIDI cable to make the connection to the computer (p. 38). Then connect audio cables or headphones (p. 18).

- Is the sound audible with headphones connected?

If sound can be heard through the headphones, then the cause may lie elsewhere, such as a short in an audio cable carrying the signal to another device, a bad connection, or a malfunction in a connected amp, mixer, or speakers.

- Is the specified Wave Expansion Board properly installed? (p. 15)

WAVE-EXP patches and rhythm sets cannot be selected unless the Wave Expansion Board is installed in the designated slot.

- Is the **COMPUTER** switch on the JV-1010's rear panel set to the correct position?

When using the JV-1010 while connected to a computer, set the switch to the position appropriate for the connection method, type of computer being used, and the driver settings (p. 38).

* Before changing the **COMPUTER** switch setting, first switch off the power to the JV-1010.

Songs are not played back correctly.

- Are you playing songs created for the GS format?

While the JV-1010 is compatible with the General MIDI System, GS Format is not supported, so such songs may not play back correctly.

- If playing back GM scores, is the sound generator in GM mode?

Switch to GM mode (p. 31).

No sound is produced, even when playing back songs.

- Is the Rx Switch parameter set to OFF?

Set this to ON.

There is no sound for a specific part.

- Is the volume level for the part turned down?

Raise the volume for the part for which no sound is being produced with the **Level** setting (p. 44).

- Is reception of MIDI messages enabled?

Set the Rx Switch parameter to ON.

- Does the part's MIDI receive channel match the MIDI transmit channel of the connected MIDI device?

Set the MIDI receive channel with the Channel parameter.

The sound is distorted.

- Is a distortion-type effect being applied to the sound?

If the sound for a specific patch or part is distorted, lower the volume level on that part (p. 44).

When the overall sound is distorted, lower the volume level with the VOLUME knob.

The pitch has shifted.

- Has the JV-1010's tuning been shifted?

Check the **Master Tune** value (p. 50).

- Have the **Coarse Tune** and **Fine Tune** settings for the specific parts been made?

Check the values for the **Coarse Tune** and **Fine Tune** settings (p. 44).

The JV-1010 does not output MIDI data.

- Is the **COMPUTER** switch on the JV-1010's rear panel set correctly?

When outputting JV-1010 data through the **COMPUTER** connector, set the **COMPUTER** switch to **PC-2** or **Mac** according to the computer and software being used (p. 38).

The JV-1010 does not output data from the **COMPUTER** connector when the **COMPUTER** switch is set to **MIDI**. In this case, data is output from the **MIDI OUT** connector.

The sound is interrupted.

- Is the polyphony (maximum number of voices) being exceeded?

When more than 64 voices are used simultaneously, the voices exceeding this limit of 64 are interrupted.

Set a sufficiently high value as the **Voice Reserve** setting for parts you want to make sure are not interrupted (p. 44).

Error Messages

An error message appears in the display when an error in operation occurs, or if an operation cannot be processed correctly. When this occurs, continue by following the instructions indicated in the error message.

coE (MIDI Communication Error)

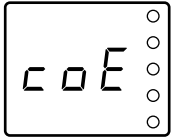

Situation: There is a problem with the MIDI cable connected to the JV-1010's MIDI IN connector or with an external device. However, this message is also displayed when the power for the external device is turned off.

Action: Check to make sure the MIDI cable is firmly and properly connected. Otherwise confirm that there is no short in the MIDI cable (try switching the MIDI cable to check this).

bFL (MIDI Buffer Full)

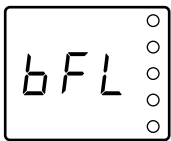

Situation: More MIDI messages were received in a short time than could be processed correctly.

Action: Reduce the amount of MIDI messages that are transmitted.

cSE (MIDI Check Sum Error)

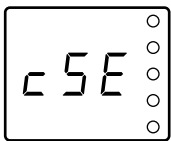

Situation: A system exclusive message that was received had an incorrect check sum value.

Action: Correct the check sum value.

rdE (Receive Data Error)

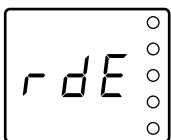

Situation: A system exclusive message was not properly received. Repeated appearance of this same error message means that there is a problem with the MIDI message.

Action: Check the content of the received system exclusive message.

noP (No Patch)

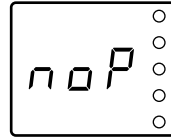

Situation: If no expansion board is installed, then an expansion board patch or rhythm set is specified from the external MIDI device.

Action: Reselect the patch and rhythm set.

und (User Memory Damaged)

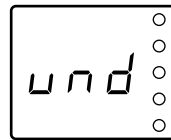

Situation: USER data has been damaged.

Action: Restore the factory settings with the Factory Reset procedure.

btL (Battery Low)

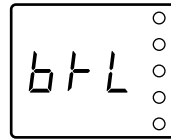

Situation: Battery power used for saving parameter settings has been used up.

Action: Take the JV-1010 to your dealer or nearby Roland Service to have the battery exchanged.

Patch List

USER (User Group)

No.	Name	Voice	Key Assign
001	Tremendously	4	POLY
002	St.Concert	4	POLY
003	CyberTrance2	4	POLY
004	SessionNyn2	3	POLY
005	ViennaStrgs3	4	POLY
006	R&R Brass	3	POLY
007	Velo Power	4	POLY
008	Super Tenor	3	POLY
009	Breathy Humz	2	POLY
010	Ow Bass	1	SOLO
011	Dunes	4	POLY
012	Celestial 2	4	POLY
013	Tone Wh.Solo	3	POLY
014	Poly Brs	4	POLY
015	Combing Slow	3	POLY
016	SA Rhodes 5	3	POLY
017	Adrenaline	4	POLY
018	DanceStack 1	3	POLY
019	Flying Waltz	4	POLY
020	East Europe	2	POLY
021	Silky Way	2	POLY
022	Techno Dream	3	POLY
023	Raverborg	4	POLY
024	Pan Pipes	2	POLY
025	Pretty Bells	2	POLY
026	Glistening	4	POLY
027	Metal Solo	4	POLY
028	StateXLChrd2	4	SOLO
029	Raggatronic	4	POLY
030	ChristmasFlt	2	POLY
031	Acc.de Paris	2	POLY
032	DreamVoices2	2	POLY
033	VintageCall2	4	POLY
034	Trancing Pad	2	POLY
035	OldiesOrgan2	2	POLY
036	X...? Whistle	3	POLY
037	Analog Drama	3	POLY
038	BPF Lead	1	POLY
039	Clean Tele	4	POLY
040	Earth Blow	2	POLY
041	Pulsatronic	3	POLY
042	Funky Slap	1	SOLO
043	Echo Rhodes	4	POLY
044	pp Harmonium	1	POLY
045	Blue Notes	4	POLY
046	Aurora	4	POLY
047	Breathy Brs	3	POLY
048	Enlighten	4	POLY
049	Tube Smoke	2	POLY
050	Perelandra	4	POLY
051	SquareLead 2	2	POLY
052	Shadows	4	POLY
053	Organizer	3	POLY
054	Full Orchest	4	POLY
055	B'on d'moov!	3	POLY
056	Sugar Bell 2	4	POLY
057	Player's EP	2	POLY
058	4pole Bass	2	SOLO
059	Octapad	3	POLY
060	Tria Bells	4	POLY
061	Wire Pad	3	POLY
062	Singing'Mini	1	SOLO
063	Heirborne	4	POLY
064	Trumpet	2	POLY

PR-A (Preset A Group)

No.	Name	Voice	Key Assign
001	64voicePiano	1	POLY
002	Bright Piano	1	POLY
003	Classique	2	POLY
004	Nice Piano	3	POLY
005	Piano Thang	3	POLY
006	Power Grand	3	POLY
007	House Piano	2	POLY
008	E.Grand	1	POLY
009	MIDled Grand	3	POLY
010	Piano Blend	3	POLY
011	West Coast	4	POLY
012	PianoStrings	4	POLY
013	Bs/Pno+Brs	4	POLY
014	Waterhodes	2	POLY
015	S.A.E.P.	3	POLY
016	SA Rhodes 1	4	POLY
017	SA Rhodes 2	2	POLY
018	Stiky Rhodes	3	POLY
019	Dig Rhodes	2	POLY
020	Nylon EPiano	4	POLY
021	Nylon Rhodes	4	POLY
022	Rhodes Mix	3	POLY
023	PsychoRhodes 2	POLY	
024	Tremo Rhodes	4	POLY
025	MK-80 Rhodes	1	POLY
026	MK-80 Phaser	1	POLY
027	Delicate EP	2	POLY
028	Octa Rhodes1	4	POLY
029	Octa Rhodes2	4	POLY
030	JV Rhodes+	4	POLY
031	EP+Mod Pad	4	POLY
032	Mr.Mellow	4	POLY
033	Comp Clav	1	POLY
034	Klavinet	4	POLY
035	Winger Clav	4	POLY
036	Phaze Clav 1	2	POLY
037	Phaze Clav 2	1	POLY
038	Phuzz Clav	2	POLY
039	Chorus Clav	1	POLY
040	Claviduck	2	POLY
041	Velo-Rez Clv	1	POLY
042	Clavicembalo	4	POLY
043	Analog Clav1	1	POLY
044	Analog Clav2	1	POLY
045	Metal Clav	3	POLY
046	Full Stops	2	POLY
047	Ballad B	3	POLY
048	Mellow Bars	4	POLY
049	AugerMentive	3	POLY
050	Perky B	2	POLY
051	The Big Spin	3	POLY
052	Gospel Spin	3	POLY
053	Roller Spin	3	POLY
054	Rocker Spin	3	POLY
055	Tone Wh.Solo	3	POLY
056	Purple Spin	4	POLY
057	60's LeadORG	2	POLY
058	Assalt Organ	3	POLY
059	D-50 Organ	2	POLY
060	Cathedral	4	POLY
061	Church Pipes	4	POLY
062	Poly Key	3	POLY
063	Poly Saws	4	POLY
064	Poly Pulse	4	POLY

No.	Name	Voice	Key Assign
065	Steel Away	3	POLY
066	D-50 Stack	4	POLY
067	Solo Strat	3	POLY
068	Soap Opera	1	POLY
069	Sop.Sax mf	2	POLY
070	Dimensional	2	POLY
071	Blusey OD	2	POLY
072	Stacc.Heaven	4	POLY
073	PhaseBlipper	2	POLY
074	Pure Tibet	1	POLY
075	Afterlife	3	POLY
076	Perky B	2	POLY
077	JUNO Power!	4	POLY
078	SessionBrass	4	POLY
079	JX SqrCarpet	2	POLY
080	Phaser MC	2	POLY
081	Sweep Clav 2	3	POLY
082	BluesHarp	1	POLY
083	Scat Flute	2	POLY
084	5thPad 2	4	POLY
085	Belfry Chime	3	POLY
086	Atmos Harp	4	POLY
087	DesertCrystl	4	POLY
088	December Sky	4	POLY
089	Upright Pno	3	POLY
090	Darkshine	4	POLY
091	Exotic Velo	4	POLY
092	Atlantis 2	4	POLY
093	Creamy	2	POLY
094	Morning Lite	2	POLY
095	DanceStack 5	4	POLY
096	D50FantaPerc	3	POLY
097	Resojuice	2	SOLO
098	Silicon Str	4	POLY
099	Keep :-)	2	POLY
100	Sm.Brass Grp	4	POLY
101	Echo Piano	3	POLY
102	HeavenlyPad	2	POLY
103	Sequalog	4	POLY
104	Solo Steel	4	POLY
105	Spectrum Mod	4	POLY
106	Delicate EP	2	POLY
107	Triumph Brs	3	POLY
108	Flute	1	POLY
109	2.2 Bell Pad	4	POLY
110	JustLovely 2	1	POLY
111	GR500 TmpDly	2	POLY
112	Dawn 2 Dusk	3	POLY
113	Gluey Pad	3	POLY
114	SquareKeys 3	2	POLY
115	Arasian Morn	4	POLY
116	D'light	2	POLY
117	Perky Noize	3	POLY
118	Mod DirtyWav	3	POLY
119	Moving Glass	1	POLY
120	Sci-Fi Str	3	POLY
121	OD 5ths	3	POLY
122	Far East	4	POLY
123	Phobos	2	POLY
124	Cyber Dreams	3	POLY
125	Cave 2	4	POLY
126	Helium Queen	4	SOLO
127	Rain Forest	4	POLY
128	Crowds	4	POLY

Voice: number of voice

PR-B (Preset B Group)

No.	Name	Voice	Key Assign	No.	Name	Voice	Key Assign
001	Dist Gtr 1	3	POLY	065	Analog Seq	2	POLY
002	Dist Gtr 2	3	POLY	066	Impact Vox	4	POLY
003	R&R Chunk	4	POLY	067	TeknoSoloVox	2	POLY
004	Phripphuzz	1	SOLO	068	X-Mod Man	2	POLY
005	Grungeroni	3	POLY	069	Paz <==> Zap	1	SOLO
006	Black Widow	4	POLY	070	4 Hits 4 You	4	POLY
007	Velo-Wah Gtr	1	POLY	071	Impact	4	POLY
008	Mod-Wah Gtr	2	POLY	072	Phase Hit	3	POLY
009	Pick Bass	1	SOLO	073	Tekno Hit 1	2	POLY
010	Hip Bass	2	POLY	074	Tekno Hit 2	2	POLY
011	Perc.Bass	3	SOLO	075	Tekno Hit 3	4	POLY
012	Homey Bass	2	SOLO	076	Reverse Hit	3	POLY
013	Finger Bass	1	SOLO	077	SquareLead 1	3	POLY
014	Nylon Bass	2	POLY	078	SquareLead 2	2	POLY
015	Ac.Upright	1	SOLO	079	You and Luck	2	SOLO
016	Wet Fretls	1	SOLO	080	Belly Lead	4	POLY
017	Fretls Dry	2	POLY	081	WhistlinAtom	2	POLY
018	Slap Bass 1	2	POLY	082	Edye Boost	2	SOLO
019	Slap Bass 2	1	SOLO	083	MG Solo	4	SOLO
020	Slap Bass 3	1	SOLO	084	FXM Saw Lead	4	SOLO
021	Slap Bass 4	2	POLY	085	Sawteeth	3	SOLO
022	4 Pole Bass	1	SOLO	086	Smoothie	2	SOLO
023	Tick Bass	4	SOLO	087	MG Lead	2	SOLO
024	House Bass	3	SOLO	088	MG Interval	4	SOLO
025	Mondo Bass	3	SOLO	089	Pulse Lead 1	3	POLY
026	Clk AnalogBs	2	SOLO	090	Pulse Lead 2	4	SOLO
027	Bass In Face	2	POLY	091	Little Devil	4	SOLO
028	101 Bass	2	SOLO	092	Loud SynLead	4	SOLO
029	Noiz Bass	2	SOLO	093	Analog Lead	2	SOLO
030	Super Jup Bs	2	POLY	094	5th Lead	2	SOLO
031	Occitan Bass	3	POLY	095	Flute	2	POLY
032	Hugo Bass	4	SOLO	096	Piccolo	1	POLY
033	Multi Bass	2	POLY	097	VOX Flute	4	POLY
034	Moist Bass	2	SOLO	098	Air Lead	2	POLY
035	BritelowBass	4	SOLO	099	Pan Pipes	2	POLY
036	Untamed Bass	3	SOLO	100	Airplaaane	4	POLY
037	Rubber Bass	3	SOLO	101	Taj Mahal	1	POLY
038	Stereoww Bs	3	SOLO	102	Raya Shaku	3	POLY
039	Wonder Bass	3	SOLO	103	Oboe mf	1	POLY
040	Deep Bass	2	POLY	104	Oboe Express	2	POLY
041	Super JX Bs	2	SOLO	105	Clarinet mp	1	POLY
042	W-<RED>-Bass	4	POLY	106	ClariExpress	2	POLY
043	HI-Ring Bass	3	POLY	107	Mitzva Split	4	POLY
044	Euro Bass	2	SOLO	108	ChamberWinds	4	POLY
045	SinusoidRave	1	SOLO	109	ChamberWoods3	4	POLY
046	Alternative	2	SOLO	110	Film Orch	4	POLY
047	Acid Line	1	SOLO	111	Sop.Sax mf	2	POLY
048	Auto TB-303	3	SOLO	112	Alto Sax	3	POLY
049	Hihat Tekno	2	POLY	113	AltoLead Sax	3	POLY
050	Velo Tekno 1	3	SOLO	114	Tenor Sax	3	POLY
051	Raggatronic	4	POLY	115	Baritone Sax	3	POLY
052	Blade Racer	4	POLY	116	Take A Tenor	4	POLY
053	S&H Pad	1	POLY	117	Sax Section	4	POLY
054	Syncozonix	3	POLY	118	Bigband Sax	4	POLY
055	Fooled Again	1	POLY	119	Harmonica	2	POLY
056	Alive	3	POLY	120	Harmo Blues	2	POLY
057	Velo Tekno 2	2	POLY	121	BluesHarp	1	POLY
058	Rezoid	4	POLY	122	Hillbillys	4	POLY
059	Raverborg	4	POLY	123	French Bags	4	POLY
060	Blow Hit	4	POLY	124	Majestic Tpt	1	SOLO
061	Hammer Bell	3	POLY	125	Voluntare	2	POLY
062	Seq Mallet	2	POLY	126	2Trumpets	2	POLY
063	Intentions	3	POLY	127	Tpt Sect	4	POLY
064	Pick It	3	POLY	128	Mute TP mod	4	POLY

PR-C (Preset C Group)

No.	Name	Voice	Key Assign	No.	Name	Voice	Key Assign
001	Harmon Mute	1	POLY	065	Harmonicum	2	POLY
002	Tp&Sax Sect	4	POLY	066	D-50 Heaven	2	POLY
003	Sax+Tp+Tb	3	POLY	067	Afro Horns	3	POLY
004	Brass Sect	4	POLY	068	Pop Pad	4	POLY
005	Trombone	1	POLY	069	Dreamesque	4	POLY
006	Hybrid Bones	4	POLY	070	Square Pad	4	POLY
007	Noble Horns	4	POLY	071	JP-8 Hollow	4	POLY
008	Massed Horns	3	POLY	072	JP-8Haunting	4	POLY
009	Horn Swell	4	POLY	073	Heirborne	4	POLY
010	Brass It!	4	POLY	074	Hush Pad	4	POLY
011	Brass Attack	3	POLY	075	Jet Pad 1	2	POLY
012	Archimede	3	POLY	076	Jet Pad 2	2	POLY
013	Rugby Horn	3	POLY	077	Phaze Pad	3	POLY
014	MKS-80 Brass	2	POLY	078	Phaze Str	4	POLY
015	True ANALOG	2	POLY	079	Jet Str Ens	2	POLY
016	Dark Vox	2	POLY	080	Pivotal Pad	4	POLY
017	RandomVowels	4	POLY	081	3D Flanged	1	POLY
018	Angels Sing	2	POLY	082	Fantawine	4	POLY
019	Pvox Oooze	3	POLY	083	Glassy Pad	3	POLY
020	Longing...	3	POLY	084	Moving Glass	1	POLY
021	Arasian Morn	4	POLY	085	Glasswaves	3	POLY
022	Beauty Vox	3	POLY	086	Shiny Pad	4	POLY
023	Mary-AnneVox	4	POLY	087	ShiftedGlass	2	POLY
024	Belltree Vox	4	POLY	088	Chime Pad	3	POLY
025	Vox Panner	2	POLY	089	Spin Pad	2	POLY
026	Spaced Voxx	4	POLY	090	Rotary Pad	4	POLY
027	Glass Voices	3	POLY	091	Dawn 2 Dusk	3	POLY
028	Tubular Vox	4	POLY	092	Aurora	4	POLY
029	Velo Voxx	2	POLY	093	Strobe Mode	4	POLY
030	Wavox	3	POLY	094	Albion	2	POLY
031	Doos	1	POLY	095	Running Pad	4	POLY
032	Synvox Comps	4	POLY	096	Stepped Pad	4	POLY
033	Vocal Oohz	3	POLY	097	Random Pad	4	POLY
034	LFO Vox	1	POLY	098	SoundtrkDANC	4	POLY
035	St.Strings	2	POLY	099	Flying Waltz	4	POLY
036	Warm Strings	4	POLY	100	Vanishing	1	POLY
037	Somber Str	4	POLY	101	5th Sweep	4	POLY
038	Marcato	2	POLY	102	Phazweep	4	POLY
039	Bright Str	2	POLY	103	Big BPF	4	POLY
040	String Ens	4	POLY	104	MG Sweep	4	POLY
041	TremoloStrng	2	POLY	105	CeremonyTimp	3	POLY
042	Chambers	3	POLY	106	Dyno Toms	4	POLY
043	ViolinCello	4	POLY	107	Sands ofTime	4	POLY
044	Symphonique	4	POLY	108	Inertia	4	POLY
045	Film Octaves	4	POLY	109	Vektogram	4	POLY
046	Film Layers	4	POLY	110	Crash Pad	4	POLY
047	Bass Pizz	4	POLY	111	Feedback VOX	4	POLY
048	Real Pizz	3	POLY	112	Cascade	1	POLY
049	Harp On It	3	POLY	113	Shattered	2	POLY
050	Harp	2	POLY	114	NextFrontier	2	POLY
051	JP-8 Str 1	2	POLY	115	Pure Tibet	1	POLY
052	JP-8 Str 2	3	POLY	116	Chime Wash	4	POLY
053	E-Motion Pad	4	POLY	117	Night Shade	4	POLY
054	JP-8 Str 3	4	POLY	118	Tortured	4	POLY
055	Vintage Orch	4	POLY	119	Dissimilate	4	POLY
056	JUNO Strings	3	POLY	120	Dunes	4	POLY
057	Gigantalog	4	POLY	121	Ocean Floor	1	POLY
058	PWM Strings	3	POLY	122	Cyber Space	3	POLY
059	Warmth	2	POLY	123	Biosphere	2	POLY
060	ORBit Pad	2	POLY	124	Variable Run	4	POLY
061	Deep Strings	2	POLY	125	Ice Hall	2	POLY
062	Pulsify	4	POLY	126	ComputerRoom	4	POLY
063	Pulse Pad	4	POLY	127	Inverted	4	POLY
064	Greek Power	4	POLY	128	Terminate	3	POLY

Voice: number of voice

Patch List

PR-D (GM Group)

No.	Name	Voice	Key Assign	No.	Name	Voice	Key Assign
001	Piano 1	2	POLY	065	Soprano Sax	1	POLY
002	Piano 2	2	POLY	066	Alto Sax	1	POLY
003	Piano 3	2	POLY	067	Tenor Sax	1	POLY
004	Honky-tonk	2	POLY	068	Baritone Sax	2	POLY
005	E.Piano 1	2	POLY	069	Oboe	2	POLY
006	E.Piano 2	4	POLY	070	English Horn	2	POLY
007	Harpsichord	2	POLY	071	Bassoon	2	POLY
008	Clav.	2	POLY	072	Clarinet	1	POLY
009	Celesta	1	POLY	073	Piccolo	1	POLY
010	Glockenspiel	2	POLY	074	Flute	1	POLY
011	Music Box	1	POLY	075	Recorder	2	POLY
012	Vibraphone	1	POLY	076	Pan Flute	2	POLY
013	Marimba	2	POLY	077	Bottle Blow	2	POLY
014	Xylophone	2	POLY	078	Shakuhachi	1	POLY
015	Tubular-bell	2	POLY	079	Whistle	1	POLY
016	Santur	2	POLY	080	Ocarina	2	POLY
017	Organ 1	1	POLY	081	Square Wave	2	POLY
018	Organ 2	1	POLY	082	Saw Wave	2	POLY
019	Organ 3	2	POLY	083	Syn.Calliope	2	POLY
020	Church Org.1	2	POLY	084	Chiffer Lead	2	POLY
021	Reed Organ	1	POLY	085	Charang	3	POLY
022	Accordion Fr	2	POLY	086	Solo Vox	2	POLY
023	Harmonica	1	POLY	087	5th Saw Wave	3	POLY
024	Bandoneon	2	POLY	088	Bass & Lead	2	POLY
025	Nylon-str.Gt	1	POLY	089	Fantasia	3	POLY
026	Steel-str.Gt	1	POLY	090	Warm Pad	2	POLY
027	Jazz Gt.	1	POLY	091	Polysynth	2	POLY
028	Clean Gt.	1	POLY	092	Space Voice	2	POLY
029	Muted Gt.	1	POLY	093	Bowed Glass	3	POLY
030	Overdrive Gt	1	POLY	094	Metal Pad	2	POLY
031	DistortionGt	1	POLY	095	Halo Pad	3	POLY
032	Gt.Harmonics	3	POLY	096	Sweep Pad	2	POLY
033	Acoustic Bs.	3	POLY	097	Ice Rain	2	POLY
034	Fingered Bs.	1	POLY	098	Soundtrack	2	POLY
035	Picked Bs.	1	POLY	099	Crystal	2	POLY
036	Fretless Bs.	1	POLY	100	Atmosphere	2	POLY
037	Slap Bass 1	1	POLY	101	Brightness	3	POLY
038	Slap Bass 2	2	POLY	102	Goblin	2	POLY
039	Synth Bass 1	1	POLY	103	Echo Drops	2	POLY
040	Synth Bass 2	1	POLY	104	Star Theme	2	POLY
041	Violin	1	POLY	105	Sitar	1	POLY
042	Viola	1	POLY	106	Banjo	1	POLY
043	Cello	1	POLY	107	Shamisen	2	POLY
044	Contrabass	1	POLY	108	Koto	1	POLY
045	Tremolo Str	1	POLY	109	Kalimba	1	POLY
046	PizzicatoStr	1	POLY	110	Bag Pipe	3	POLY
047	Harp	2	POLY	111	Fiddle	1	POLY
048	Timpani	1	POLY	112	Shanai	1	POLY
049	Strings	2	POLY	113	Tinkle Bell	4	POLY
050	Slow Strings	1	POLY	114	Agogo	1	POLY
051	Syn.Strings1	2	POLY	115	Steel Drums	1	POLY
052	Syn.Strings2	2	POLY	116	Woodblock	1	POLY
053	Choir Aahs	3	POLY	117	Taiko	4	POLY
054	Voice Oohs	1	POLY	118	Melo. Tom 1	2	POLY
055	SynVox	1	POLY	119	Synth Drum	2	POLY
056	OrchestraHit	2	POLY	120	Reverse Cym.	2	POLY
057	Trumpet	2	POLY	121	Gt.FretNoise	1	POLY
058	Trombone	1	POLY	122	Breath Noise	2	POLY
059	Tuba	2	POLY	123	Seashore	3	POLY
060	MutedTrumpet	1	POLY	124	Bird	4	POLY
061	French Horn	2	POLY	125	Telephone 1	1	POLY
062	Brass 1	2	POLY	126	Helicopter	2	POLY
063	Synth Brass1	1	POLY	127	Applause	4	POLY
064	Synth Brass2	2	POLY	128	Gun Shot	2	POLY

PR-E (Preset E Group)

No.	Name	Voice	Key Assign	No.	Name	Voice	Key Assign
001	Echo Piano	3	POLY	065	Civilization	3	POLY
002	Upright Pno	3	POLY	066	Mental Chord	4	SOLO
003	RD-1000	3	POLY	067	House Chord	4	SOLO
004	Player's EP	2	POLY	068	Sequalog	4	POLY
005	D-50 Rhodes	4	POLY	069	Booster Bips	2	POLY
006	Innocent EP	2	POLY	070	VintagePlunk	4	SOLO
007	Echo Rhodes	4	POLY	071	Plik-Plok	2	POLY
008	See-Thru EP	3	POLY	072	RingSequence	4	POLY
009	FM BellPiano	3	POLY	073	Cyber Swing	4	POLY
010	Ring E.Piano	4	POLY	074	Keep :-)	2	POLY
011	Soap Opera	1	POLY	075	Resojuice	2	SOLO
012	Dirty Organ	3	POLY	076	B'on d'moov!	3	POLY
013	Surf's Up!	2	POLY	077	Dist TB-303	2	SOLO
014	Organesque	3	POLY	078	Temple of JV	4	POLY
015	pp Harmonium	1	POLY	079	Planet Asia	4	POLY
016	PieceOfCheez	1	POLY	080	Afterlife	3	POLY
017	Harpsy Clav	2	POLY	081	Trancing Pad	2	POLY
018	Exotic Velo	4	POLY	082	Pulsatronic	3	POLY
019	Holiday Cheer	4	POLY	083	Cyber Dreams	3	POLY
020	Morning Lite	2	POLY	084	Warm Pipe	1	SOLO
021	Prefab Chime	3	POLY	085	Pure Pipe	2	POLY
022	Belfry Chime	3	POLY	086	SH-2000	2	SOLO
023	Stacc.Heaven	4	POLY	087	X..? Whistle	3	POLY
024	2.2 Bell Pad	4	POLY	088	Jay Vee Solo	3	POLY
025	Far East	4	POLY	089	Progresso Ld	4	SOLO
026	Wire Pad	3	POLY	090	Adrenaline	4	POLY
027	PhaseBlipper	2	POLY	091	Enlighten	4	POLY
028	Sweep Clav	3	POLY	092	Glass Blower	3	POLY
029	Glider	2	POLY	093	Earth Blow	2	POLY
030	Solo Steel	4	POLY	094	JX SqrCarpet	2	POLY
031	DesertCrystl	4	POLY	095	Dimensional	2	POLY
032	Clear Guitar	3	POLY	096	Jupiterings	2	POLY
033	Solo Strat	3	POLY	097	Analog Drama	3	POLY
034	Feed Me!	4	POLY	098	Rich Dynapad	4	POLY
035	Tube Smoke	2	POLY	099	Silky Way	2	POLY
036	Creamy	2	POLY	100	Gluey Pad	3	POLY
037	Blusey OD	2	POLY	101	BandPass Mod	2	POLY
038	Grindstone	2	POLY	102	Soundtraque	2	POLY
039	OD 5ths	3	POLY	103	Translucence	4	POLY
040	East Europe	2	POLY	104	Darkshine	4	POLY
041	Dulcitar	4	POLY	105	D'light	2	POLY
042	Atmos Harp	4	POLY	106	December Sky	4	POLY
043	Pilgrimage	4	POLY	107	Octapad	3	POLY
044	202 Rude Bs	2	SOLO	108	JUNO Power!	4	POLY
045	2pole Bass	2	SOLO	109	Spectrum Mod	4	POLY
046	4pole Bass	2	SOLO	110	Stringsheen	3	POLY
047	Phaser MC	2	POLY	111	GR500 TmpDly	2	POLY
048	Miniphaser	2	POLY	112	Muddy DirtyWav	3	POLY
049	Acid TB	1	SOLO	113	Silicon Str	4	POLY
050	Full Orchest	4	POLY	114	D50FantaPerc	3	POLY
051	Str + Winds	4	POLY	115	Rotodreams	3	POLY
052	Flute 2080	2	POLY	116	Blue Notes	4	POLY
053	Scat Flute	2	POLY	117	RiversOfTime	4	POLY
054	Sax Choir	4	POLY	118	Phobos	2	POLY
055	Ballad Trump	4	POLY	119	2 0 8 0	4	POLY
056	Sm.Brass Grp	4	POLY	120	Unearthly	4	POLY
057	Royale	4	POLY	121	Glistening	4	POLY
058	Brass Mutes	2	POLY	122	Sci-Fi Str	3	POLY
059	Breathy Brs	3	POLY	123	Shadows	4	POLY
060	3 Osc Brass	3	POLY	124	Helium Queen	4	SOLO
061	P5 Polymod	2	POLY	125	Sci-Fi FX x4	1	POLY
062	Triumph Brs	3	POLY	126	Perky Noize	3	POLY
063	Techno Dream	3	POLY	127	Droplet	3	POLY
064	Organizer	3	POLY	128	Rain Forest	4	POLY

Voice: number of voice

XP-A (Session)

No.	Name	Voice	No.	Name	Voice	No.	Name	Voice	No.	Name	Voice
001	St.Concert	4	065	Fr.Accord 2	2	129	Quixelate	4	193	Build-Up Syn	3
002	9ft.Grand 1	4	066	Troubadour	3	130	Trangoa Wave	2	194	Atlantis 2	4
003	9ft.Grand 2	4	067	SessionNylon	3	131	Spiked Cheez	3	195	Perelandra	4
004	Euro Classic	2	068	Solo Nylon 1	3	132	Glassy Cheez	3	196	Plutonium	4
005	St.Pno & Str	4	069	Solo Nylon 2	2	133	Super 808Cow	4	197	Nautilus	2
006	Compress Pno	1	070	Nylon & Str	4	134	Arpeggiatoid	4	198	Metal Dreams	2
007	LA Session	4	071	Nylon & Flt	3	135	Euro Hit 1	4	199	Glass Clouds	4
008	Water Piano	4	072	Nylon Chord	3	136	Euro Hit 2	2	200	Harmonicloud	4
009	Vibra Rhodes	3	073	Stratar	2	137	Rave Slice	1	201	Shining Veil	3
010	Stack Rhodes	4	074	Clean Tele	4	138	Str Torture	2	202	Ethereal JX	2
011	ArcoEnsemble	2	075	Nashville	1	139	Juno Harpsi	3	203	Striking 5th	4
012	Vienna Strgs	3	076	Super Trem	4	140	Big Mess Pad	4	204	Meow 5ths	2
013	Str Adagio	2	077	SpaghettiGtr	2	141	Harpichoir	4	205	Stepflanger	3
014	Oct Strings	3	078	Duanne'sTone	2	142	Echo Juno	3	206	Happy LFOs	4
015	Silky Filter	2	079	Big Hair Ld	2	143	Phazerave	2	207	Aero Insect	3
016	Soft Strings	2	080	Metal Solo	4	144	DanceStack 1	3	208	Beat Sweeper	2
017	SlowStr.Sect	2	081	Crunch Tone	1	145	DanceStack 2	4	209	Wormy Lead	3
018	GiantStrings	4	082	Overdriven	1	146	DanceStack 3	4	210	Atmo Lead	3
019	Str+Choir 1	4	083	Blues Tele	4	147	DanceStack 4	3	211	Caliolead	3
020	Str+Choir 2	4	084	Tube Double	2	148	DanceStack 5	4	212	Tweedles	2
021	Str+Choir 3	4	085	Neil's Rust	4	149	DanceStack 6	3	213	Raw PWM	2
022	Breathy Humz	2	086	Short Crunch	4	150	DanceStack 7	4	214	Voc Solo 5th	4
023	Dream Voices	2	087	X-Fade Metal	4	151	DanceStack 8	4	215	Dirty Lead	2
024	Mmmms	2	088	Velo Power	4	152	EuroteK Brs	4	216	Boostweeper1	2
025	Chorale	1	089	Phazy Chunk	4	153	Synergy Brs	4	217	Boostweeper2	2
026	Space Men	3	090	Reso Tele	1	154	PortaSynthex	3	218	B3 Fiith	4
027	Choir Mm+Aah	4	091	Wah Wah BPM	4	155	Razor VCOs	4	219	Phazed Organ	3
028	Ivory Mist	4	092	Rock P.Bass1	1	156	Big PWM	2	220	VSw Vibrafon	3
029	PercussiVox	4	093	Rock P.Bass2	2	157	Flutey Stack	2	221	SA Vibe	1
030	Mysteriouso	3	094	Rock P.Bass3	4	158	Wobbly 5th	4	222	Rich Vibes	2
031	Phase Mmhs	3	095	Big Jazz Bs	3	159	Tekno Square	3	223	SpaceGamelan	4
032	AmbientStory	4	096	BriteJazz Bs	1	160	Trance VoXX	4	224	Toy Vibe	3
033	Venus	3	097	Ch.Jazz Bs	2	161	Random Rave	3	225	Analog Bomb	2
034	SessionBrass	4	098	Mellow Jz Bs	2	162	Raver Circus	4	226	Seashore 2	4
035	Port.Tpts	2	099	Mute E.Bs	1	163	Resorave	2	227	Creation	4
036	R&R Brass	3	100	Octabahn Bs	4	164	Flangomatic	2	228	Cyberjunkie	4
037	Echo Brass	4	101	Slobbery Bs	2	165	O-Zu-Nu	4	229	Sci-Fi Bells	3
038	E.Coast Brs	4	102	Phase Worm	2	166	Sub Divided	1	230	Shine on	1
039	Bop Soli	2	103	Euro Rave Bs	2	167	Ancient Sqr	2	231	DEMO Piano1	4
040	Soft Saxes	4	104	Pumpin' Bs	3	168	Fat Flange	2	232	DEMO Piano2	4
041	Orchestral	4	105	Tech NoBase	2	169	Phaze NRG	1	233	DEMO PnoVox	3
042	Octalog Hrn	2	106	Bad Acid Bs	2	170	Phase Vox	3	234	DEMO Str 1	2
043	Tpt Soloist	1	107	CheepEcho Bs	3	171	Systemkno	4	235	DEMO Str 2	2
044	Legato Tpt	2	108	Manic Bs	4	172	On the move!	2	236	DEMO Str 3	2
045	Dyno Trumpet	2	109	JP6 Sqr Key	2	173	XP'ration	2	237	DEMO SynPuls	2
046	Ethno-Trumps	2	110	Square drops	1	174	Big Ensemble	4	238	DEMO 5thPad	4
047	Super Tenor	3	111	Celestial	3	175	Lazerette	3	239	DEMO Choir	2
048	TenorExpress	2	112	Heavenly Eko	4	176	Fazed String	4	240	DEMO Brass	1
049	T.Sax f	1	113	JD-800 Nomad	3	177	Combing Slow	3	241	DEMO Tenor	3
050	Legato Flute	2	114	Vibrolater	4	178	Jet Stack	4	242	DEMO Tpt	1
051	Touch Flute	2	115	MartianChime	4	179	Phazeslop	4	243	DEMO Flute	2
052	NewAge Flute	1	116	Big Wet Blip	4	180	Rize Mass	3	244	DEMO Nylon	4
053	Flute inMist	2	117	Amazing Echo	4	181	Portent	2	245	DEMO PhaseGt	4
054	Hybrid Flute	2	118	DelaySession	4	182	DCO Sweeper	3	246	DEMO DistGt1	4
055	Flute & Cla	3	119	Deletex	4	183	Sweep Rain	4	247	DEMO DistGt2	3
056	ChristmasFlt	2	120	Tarlia	3	184	Sweep Stack	3	248	DEMO Strat	3
057	Fifth Flute	2	121	Mahoroba	4	185	Big Vectors	4	249	DEMO SlapBs	2
058	Cosmic Flute	2	122	Eurotek Clav	2	186	Poly Swell	2	250	DEMO P.Bass	1
059	Acc.de Paris	2	123	Dope Resoclv	1	187	Alchemy	3	251	DEMO SynBs	2
060	Paris 50's	4	124	Tekno Juno	2	188	Soli-na	2	252	DEMO SynLead	4
061	Musette Ens	4	125	Buzzzzzzzzzz	2	189	90s Str Mach	4	253	DEMO Insect	4
062	Montmartre	2	126	Slop-a-rama	2	190	Ultra Cheez	2	254	DEMO Buzzzzzz	2
063	Sad Akordion	3	127	Isn't Pretty	3	191	Juno-60 Pad	3	255	DEMO Crowd	4
064	Fr.Accordion	1	128	Polywasp	1	192	Progressive	2			

Voice: number of voice

Patch Category List

PIANO (Piano Group)

PNO (AC.PIANO) Acoustic Piano

No.	Name	Voice	Preset No.
001	St.Concert	4	XP-A:001
002	9ft.Grand 1	4	XP-A:002
003	9ft.Grand 2	4	XP-A:003
004	Euro Classic	2	XP-A:004
005	DEMO Piano1	4	XP-A:231
006	DEMO Piano2	4	XP-A:232
007	64voicePiano	1	PR-A:001
008	Bright Piano	1	PR-A:002
009	Classique	2	PR-A:003
010	Nice Piano	3	PR-A:004
011	Piano Thang	3	PR-A:005
012	Power Grand	3	PR-A:006
013	Piano 1	2	PR-D:001
014	Piano 2	2	PR-D:002
015	Piano 3	2	PR-D:003
016	Compress Pno	1	XP-A:006
017	Honky-tonk	2	PR-D:004
018	Echo Piano	3	PR-E:001
019	Upright Pno	3	PR-E:002
020	St.Pno & Str	4	XP-A:005
021	PianoStrings	4	PR-A:012
022	DEMO PnoVox	3	XP-A:233
023	LA Session	4	XP-A:007
024	Piano Blend	3	PR-A:010
025	Water Piano	4	XP-A:008
026	RD-1000	3	PR-E:003
027	MIDled Grand	3	PR-A:009
028	E.Grand	1	PR-A:008

EP (EL.PIANO) Electric Piano

No.	Name	Voice	Preset No.
029	SA Rhodes1	4	PR-A:016
030	Stiky Rhodes	3	PR-A:018
031	Dig Rhodes	2	PR-A:019
032	SA Rhodes 2	2	PR-A:017
033	E.Piano 1	2	PR-D:005
034	S.A.E.P.	3	PR-A:015
035	MK-80 Rhodes	1	PR-A:025
036	Player's EP	2	PR-E:004
037	Rhodes Mix	3	PR-A:022
038	Octa Rhodes1	4	PR-A:028
039	Octa Rhodes2	4	PR-A:029
040	Waterhodes	2	PR-A:014
041	Tremo Rhodes	4	PR-A:024
042	PsychoRhodes	2	PR-A:023
043	MK-80 Phaser	1	PR-A:026
044	E.Piano 2	4	PR-D:006
045	Delicate EP	2	PR-A:027
046	FM BellPiano	3	PR-E:009
047	West Coast	4	PR-A:011
048	Mr.Mellow	4	PR-A:032
049	JV Rhodes+	4	PR-A:030
050	EP+Mod Pad	4	PR-A:031
051	D-50 Rhodes	4	PR-E:005
052	Innocent EP	2	PR-E:006
053	Echo Rhodes	4	PR-E:007
054	See-Thru EP	3	PR-E:008
055	Ring E.Piano	4	PR-E:010
056	Stack Rhodes	4	XP-A:010
057	Nylon EPiano	4	PR-A:020
058	Nylon Rhodes	4	PR-A:021
059	Vibra Rhodes	3	XP-A:009

KEY&ORGAN (Keyboard & Organ Group)

KEY (KEYBOARDS) Other Keyboards (Clav, Harpichord etc.)

No.	Name	Voice	Preset No.
001	Comp Clav	1	PR-A:033
002	Clav.	2	PR-D:008
003	Chorus Clav	1	PR-A:039
004	Clavicembalo	4	PR-A:042
005	Klavinet	4	PR-A:034
006	Metal Clav	3	PR-A:045
007	Harpsy Clav	2	PR-E:017
008	Winger Clav	4	PR-A:035
009	Phaze Clav 1	2	PR-A:036
010	Phaze Clav 2	1	PR-A:037
011	Phuzz Clav	2	PR-A:038
012	PieceOfCheez	1	PR-E:016
013	Claviduck	2	PR-A:040
014	Velo-Rez Clv	1	PR-A:041
015	Analog Clav1	1	PR-A:043
016	Analog Clav2	1	PR-A:044
017	Celesta	1	PR-D:009
018	Harpichord	2	PR-D:007
019	Harpichoir	4	XP-A:141

BEL (BELL) Bell, Bell Pad

No.	Name	Voice	Preset No.
020	Pretty Bells	2	PR-A:088
021	Wave Bells	4	PR-A:084
022	Music Bells	2	PR-A:087
023	Beauty Bells	4	PR-A:086
024	Tria Bells	4	PR-A:085
025	Crystal	2	PR-D:099
026	Tinkle Bell	4	PR-D:113
027	Ethno Metals	4	PR-A:096
028	Glockenspiel	2	PR-D:010
029	Childlike	4	PR-A:081
030	Music Box	3	PR-A:082
031	Music Box	1	PR-D:011
032	Toy Box	2	PR-A:083
033	Square Keys	2	PR-A:080
034	Vibrolater	4	XP-A:114
035	Tubular-bell	2	PR-D:015
036	Wide Tubular	4	PR-A:090
037	Belfry Chime	3	PR-E:022
038	Stacc.Heaven	4	PR-E:023
039	D-50 Stack	4	PR-A:071
040	Fantasia JV	4	PR-A:072
041	Jimmee Dee	4	PR-A:073
042	Holiday Cheer	4	PR-E:019
043	Morning Lite	2	PR-E:020
044	Heavenals	4	PR-A:074
045	2.2 Bell Pad	4	PR-E:024
046	Mallet Pad	4	PR-A:075
047	JD-800 Nomad	3	XP-A:113
048	Huff N Stuff	3	PR-A:076
049	BellVox 1080	4	PR-A:078
050	Celestial	3	XP-A:111
051	Fantasy Vox	4	PR-A:079
052	Heavenly Eko	4	XP-A:112
053	Tarlia	3	XP-A:120
054	MartianChime	4	XP-A:115
055	Hammer Bell	3	PR-B:061
056	Big Wet Blip	4	XP-A:116
057	Prefab Chime	3	PR-E:021

MLT (MALLET) Mallet

No.	Name	Voice	Preset No.
058	Warm Vibes	2	PR-A:092
059	SA Vibe	1	XP-A:221
060	Vibraphone	1	PR-D:012
061	VSw Vibrafon	3	XP-A:220
062	Rich Vibes	2	XP-A:222
063	AmbienceVibe	4	PR-A:091
064	SpaceGamelan	4	XP-A:223
065	Toy Vibe	3	XP-A:224
066	Exotic Velo	4	PR-E:018
067	Dyna Marimba	1	PR-A:093
068	Bass Marimba	4	PR-A:094
069	Marimba	2	PR-D:013
070	Nomad Perc	3	PR-A:095
071	Xylophone	2	PR-D:014
072	Steel Drums	1	PR-A:099
073	Steel Drums	1	PR-D:115
074	Islands Mlt	4	PR-A:097
075	Steelin Key	3	PR-A:098

ORG (ORGAN) Electric and Church Organ

No.	Name	Voice	Preset No.
076	Full Stops	2	PR-A:046
077	Roller Spin	3	PR-A:053
078	Gospel Spin	3	PR-A:052
079	Ballad B	3	PR-A:047
080	Mellow Bars	4	PR-A:048
081	Organ 1	1	PR-D:017
082	Organ 2	1	PR-D:018
083	AugerMentive	3	PR-A:049
084	Perky B	2	PR-A:050
085	The Big Spin	3	PR-A:051
086	Rocker Spin	3	PR-A:054
087	Tone Wh.Solo	3	PR-A:055
088	Dirty Organ	3	PR-E:012
089	Organ 3	2	PR-D:019
090	B3 Filth	4	XP-A:218
091	Purple Spin	4	PR-A:056
092	60's LeadORG	2	PR-A:057
093	Assalt Organ	3	PR-A:058
094	D-50 Organ	2	PR-A:059
095	Surf's Up!	2	PR-E:013
096	Soap Opera	1	PR-E:011
097	Phazed Organ	3	XP-A:219
098	Cathedral	4	PR-A:060
099	Church Pipes	4	PR-A:061
100	Church Org.1	2	PR-D:020
101	Organesque	3	PR-E:014
102	pp Harmonium	1	PR-E:015
103	Reed Organ	1	PR-D:021

ACD (ACCORDION) Accordion

No.	Name	Voice	Preset No.
104	Montmartre	2	XP-A:062
105	Acc.de Paris	2	XP-A:059
106	Fr.Accordion	1	XP-A:064
107	Paris 50's	4	XP-A:060
108	Fr.Accord 2	2	XP-A:065
109	Bandoneon	2	PR-D:024
110	Accordion Fr	2	PR-D:022
111	Musette Ens	4	XP-A:061
112	Sad Akordion	3	XP-A:063

HRM (HARMONICA) Harmonica, Blues Harp

No.	Name	Voice	Preset No.
113	Harmonica	2	PR-B:119
114	Harmonica	1	PR-D:023
115	Harmo Blues	2	PR-B:120
116	BluesHarp	1	PR-B:121

GUITAR/BASS (Guitar/Bass Group)

AGT (AC.GUITAR) Acoustic Guitar

No.	Name	Voice	Preset No.
001	SessionNylon	3	XP-A:067
002	Nylon Gtr	1	PR-A:108
003	Nylon-str.Gt	1	PR-D:025
004	DEMO Nylon	4	XP-A:244
005	Solo Nylon 1	3	XP-A:068
006	Solo Nylon 2	2	XP-A:069
007	Nylon & Str	4	XP-A:070
008	Gtr Strings	3	PR-A:109
009	Nylon & Flt	3	XP-A:071
010	DesertCrystl	4	PR-E:031
011	Nylon Chord	3	XP-A:072
012	Deletex	4	XP-A:119
013	Steel Away	3	PR-A:110
014	Steel-str.Gt	1	PR-D:026
015	Solo Steel	4	PR-E:030
016	12str Gtr 1	2	PR-A:112
017	12str Gtr 2	3	PR-A:113
018	Heavenly Gtr	4	PR-A:111
019	Atmosphere	2	PR-D:100
020	Gt.FretNoise	1	PR-D:121
021	Troubadour	3	XP-A:066

EGT (EL.GUITAR) Electric Guitar

No.	Name	Voice	Preset No.
022	Clean Tele	4	XP-A:074
023	Jz Gtr Hall	1	PR-A:114
024	LetterFrmPat	4	PR-A:115
025	Jazz Gt.	1	PR-D:027
026	Jazz Scat	3	PR-A:116
027	Clear Guitar	3	PR-E:032
028	Nashville	1	XP-A:075
029	Super Trem	4	XP-A:076
030	SpaghettiGtr	2	XP-A:077
031	Duanne'sTone	2	XP-A:078
032	JC Strat	1	PR-A:118
033	Twin Strats	3	PR-A:119
034	Stratar	2	XP-A:073
035	Solo Strat	3	PR-E:033
036	JV Strat	2	PR-A:120
037	Clean Gt.	1	PR-D:028
038	Syn Strat	2	PR-A:121
039	Rotary Gtr	2	PR-A:122
040	Muted Gtr	1	PR-A:123
041	SwitchOnMute	2	PR-A:124
042	Muted Gt.	1	PR-D:029
043	Gt.Harmonics	3	PR-D:032
044	Velo-Wah Gtr	1	PR-B:007
045	Wah Wah BPM	4	XP-A:091
046	Reso Tele	1	XP-A:090
047	DEMO PhaseGt	4	XP-A:245
048	DEMO Strat	3	XP-A:248

DGT (DIST.GUITAR) Distortion Guitar

No.	Name	Voice	Preset No.
049	Big Hair Ld	2	XP-A:079
050	Metal Solo	4	XP-A:080
051	Feed Me!	4	PR-E:034
052	DEMO DistGt1	4	XP-A:246
053	DEMO DistGt2	3	XP-A:247
054	Neil's Rust	4	XP-A:085
055	Crunch Tone	1	XP-A:081
056	Tube Smoke	2	PR-E:035
057	Overdriven	1	XP-A:082
058	Dist Gtr 1	3	PR-B:001
059	Dist Gtr 2	3	PR-B:002
060	RockYurSocks	4	PR-A:128
061	Creamy	2	PR-E:036
062	Blusey OD	2	PR-E:037
063	Blues Tele	4	XP-A:083
064	Grindstone	2	PR-E:038
065	Rezodrive	2	PR-A:127
066	Tube Double	2	XP-A:084
067	OD 5ths	3	PR-E:039
068	Overdrive Gt	1	PR-D:030
069	DistortionGt	1	PR-D:031
070	R&R Chunk	4	PR-B:003
071	Velo Power	4	XP-A:088
072	Short Crunch	4	XP-A:086
073	X-Fade Metal	4	XP-A:087
074	Phazy Chunk	4	XP-A:089
075	Power Trip	2	PR-A:125
076	Crunch Split	4	PR-A:126
077	Phripphuzz	1	PR-B:004
078	Grungeroni	3	PR-B:005
079	Black Widow	4	PR-B:006
080	Mod-Wah Gtr	2	PR-B:008

BS (BASS) Acoustic & Electric Bass

No.	Name	Voice	Preset No.
081	Rock P.Bass1	1	XP-A:092
082	Rock P.Bass2	2	XP-A:093
083	Rock P.Bass3	4	XP-A:094
084	Big Jazz Bs	3	XP-A:095
085	BriteJazz Bs	1	XP-A:096
086	Finger Bass	1	PR-B:013
087	Fingered Bs.	1	PR-D:034
088	Mellow Jz Bs	2	XP-A:098
089	Ch.Jazz Bs	2	XP-A:097
090	Octabahn Bs	4	XP-A:100
091	Pick Bass	1	PR-B:009
092	Picked Bs.	1	PR-D:035
093	Hip Bass	2	PR-B:010
094	Mute E.Bs	1	XP-A:099
095	Perc.Bass	3	PR-B:011
096	Homey Bass	2	PR-B:012
097	Slap Bass 1	2	PR-B:018
098	Slap Bass 2	1	PR-B:019
099	Slap Bass 3	1	PR-B:020
100	Slap Bass 4	2	PR-B:021
101	Slap Bass 1	1	PR-D:037
102	Slap Bass 2	2	PR-D:038
103	Fretls Dry	2	PR-B:017
104	Fretless Bs.	1	PR-D:036
105	Wet Fretls	1	PR-B:016
106	Nylon Bass	2	PR-B:014
107	Ac.Upright	1	PR-B:015
108	Acoustic Bs.	3	PR-D:033
109	DEMO P.Bass	1	XP-A:250
110	DEMO SlapBs	2	XP-A:249

SBS (SYNTH BASS) Synth Bass

No.	Name	Voice	Preset No.
111	4 Pole Bass	1	PR-B:022
112	Tick Bass	4	PR-B:023
113	House Bass	3	PR-B:024
114	Mondo Bass	3	PR-B:025
115	2pole Bass	2	PR-E:045
116	4pole Bass	2	PR-E:046
117	Wonder Bass	3	PR-B:039
118	Rubber Bass	3	PR-B:037
119	Stereoww Bs	3	PR-B:038
120	Clk AnalogBs	2	PR-B:026
121	Bass In Face	2	PR-B:027
122	101 Bass	2	PR-B:028
123	Noiz Bass	2	PR-B:029
124	Occitan Bass	3	PR-B:031
125	Super Jup Bs	2	PR-B:030
126	Hugo Bass	4	PR-B:032
127	Untamed Bass	3	PR-B:036
128	CheepEcho Bs	3	XP-A:107
129	Slobbery Bs	2	XP-A:101
130	Euro Rave Bs	2	XP-A:103
131	Multi Bass	2	PR-B:033
132	Moist Bass	2	PR-B:034
133	Bad Acid Bs	2	XP-A:106
134	Acid TB	1	PR-E:049
135	Synth Bass 1	1	PR-D:039
136	BritelowBass	4	PR-B:035
137	Deep Bass	2	PR-B:040
138	Super JX Bs	2	PR-B:041
139	W<RED>-Bass	4	PR-B:042
140	Synth Bass 2	1	PR-D:040
141	Tech NoBase	2	XP-A:105
142	Hi-Ring Bass	3	PR-B:043
143	Euro Bass	2	PR-B:044
144	SinusoidRave	1	PR-B:045
145	202 Rude Bs	2	PR-E:044
146	Pumpin' Bs	3	XP-A:104
147	Phaser MC	2	PR-E:047
148	Miniphaser	2	PR-E:048
149	Phase Worm	2	XP-A:102
150	Manic Bs	4	XP-A:108
151	DEMO SynBs	2	XP-A:251

Patch Category List

ORCH/BRASS (Orchestra/Brass Group)

STR (STRINGS) Strings

No.	Name	Voice	Preset No.
001	Str Adagio	2	XP-A:013
002	ArcoEnsemble	2	XP-A:011
003	Vienna Strgs	3	XP-A:012
004	Oct Strings	3	XP-A:014
005	Soft Strings	2	XP-A:016
006	GiantStrings	4	XP-A:018
007	St.Strings	2	PR-C:035
008	Warm Strings	4	PR-C:036
009	Somber Str	4	PR-C:037
010	Marcato	2	PR-C:38
011	Bright Str	2	PR-C:039
012	String Ens	4	PR-C:040
013	DEMO Str 1	2	XP-A:234
014	Strings	2	PR-D:049
015	Chambers	3	PR-C:042
016	SlowStr.Sect	2	XP-A:017
017	Silky Filter	2	XP-A:015
018	Slow Strings	1	PR-D:050
019	Film Octaves	4	PR-C:045
020	DEMO Str 2	2	XP-A:235
021	DEMO Str 3	2	XP-A:236
022	TremoloStrng	2	PR-C:041
023	Tremolo Str	1	PR-D:045
024	Str+Choir 1	4	XP-A:019
025	Str+Choir 2	4	XP-A:020
026	PizzicatoStr	1	PR-D:046
027	Bass Pizz	4	PR-C:047
028	Real Pizz	3	PR-C:048
029	Voicey Pizz	3	PR-A:100
030	Violin	1	PR-D:041
031	Fiddle	1	PR-D:111
032	ViolinCello	4	PR-C:043
033	Viola	1	PR-D:042
034	Cello	1	PR-D:043
035	Contrabass	1	PR-D:044
036	JP-8 Str 1	2	PR-C:051
037	JP-8 Str 2	3	PR-C:052
038	JP-8 Str 3	4	PR-C:054
039	Deep Strings	2	PR-C:061

ORC (ORCHESTRA) Orchestra Ensemble

No.	Name	Voice	Preset No.
040	Symphonique	4	PR-C:044
041	Film Layers	4	PR-C:046
042	Full Orchest	4	PR-E:050
043	Str + Winds	4	PR-E:051
044	Film Orch	4	PR-B:110

HIT (HIT&STAB) Orchestra Hit, Hit

No.	Name	Voice	Preset No.
045	OrchestraHit	2	PR-D:056
046	Impact	4	PR-B:071
047	Phase Hit	3	PR-B:072
048	Reverse Hit	3	PR-B:076
049	Tekno Hit 1	2	PR-B:073
050	Tekno Hit 2	2	PR-B:074
051	Tekno Hit 3	4	PR-B:075
052	Euro Hit 1	4	XP-A:135
053	Euro Hit 2	2	XP-A:136
054	Rave Slice	1	XP-A:137
055	Blow Hit	4	PR-B:060
056	4 Hits 4 You	4	PR-B:070

WND (WIND)

Winds (Oboe, Clarinet etc.)

No.	Name	Voice	Preset No.
057	Oboe mf	1	PR-B:103
058	Oboe Express	2	PR-B:104
059	Oboe	2	PR-D:069
060	English Horn	2	PR-D:070
061	Bassoon	2	PR-D:071
062	Clarinet mp	1	PR-B:105
063	ClariExpress	2	PR-B:106
064	Clarinet	2	PR-D:072
065	ChamberWinds	4	PR-B:108
066	ChamberWoods	3	PR-B:109
067	Mitzva Split	4	PR-B:107

FLT (FLUTE) Flute, Piccolo

No.	Name	Voice	Preset No.
068	Legato Flute	2	XP-A:050
069	Flute	2	PR-B:095
070	Flute	1	PR-D:074
071	Flute 2080	2	PR-E:052
072	Touch Flute	2	XP-A:051
073	DEMO Flute	2	XP-A:243
074	Fifth Flute	2	XP-A:057
075	Piccolo	1	PR-B:096
076	Piccolo	1	PR-D:073
077	Pan Pipes	2	PR-B:099
078	Pan Flute	2	PR-D:076
079	Bottle Blow	2	PR-D:077
080	Air Lead	2	PR-B:098
081	Recorder	2	PR-D:075
082	Ocarina	2	PR-D:080
083	Whistle	1	PR-D:079
084	VOX Flute	4	PR-B:097
085	Scat Flute	2	PR-E:053
086	NewAge Flute	1	XP-A:052
087	Cosmic Flute	2	XP-A:058
088	Flute inMist	2	XP-A:053
089	Flute & Cla	3	XP-A:055
090	Hybrid Flute	2	XP-A:054
091	ChristmasFlt	2	XP-A:056

BRS (AC.BRASS) Acoustic Brass

No.	Name	Voice	Preset No.
092	SessionBrass	4	XP-A:034
093	E.Coast Brs	4	XP-A:038
094	R&R Brass	3	XP-A:036
095	Port.Tpts	2	XP-A:035
096	Brass Sect	4	PR-C:004
097	Tpt Sect	4	PR-B:127
098	Brass 1	2	PR-D:062
099	DEMO Brass	1	XP-A:240
100	Echo Brass	4	XP-A:037
101	Royale	4	PR-E:057
102	Sm.Brass Grp	4	PR-E:056
103	Tp&Sax Sect	4	PR-C:002
104	Sax+Tp+Tb	3	PR-C:003
105	Hybrid Bones	4	PR-C:006
106	Bop Soli	2	XP-A:039
107	Orchestral	4	XP-A:041
108	Noble Horns	4	PR-C:007
109	Horn Swell	4	PR-C:009
110	Massed Horns	3	PR-C:008
111	French Horn	2	PR-D:061
112	Majestic Tpt	1	PR-B:124
113	Voluntare	2	PR-B:125
114	Tpt Soloist	1	XP-A:043
115	Legato Tpt	2	XP-A:044
116	Dyno Trumpet	2	XP-A:045
117	DEMO Tpt	1	XP-A:242
118	Trumpet	2	PR-D:057
119	Ballad Trump	4	PR-E:055
120	2Trumpets	2	PR-B:126
121	Ethno-Trumps	2	XP-A:046
122	Harmon Mute	1	PR-C:001
123	Mute TP mod	4	PR-B:128
124	MutedTrumpet	1	PR-D:060
125	Brass Mutes	2	PR-E:058
126	Trombone	1	PR-C:005
127	Trombone	1	PR-D:058
128	Tuba	2	PR-D:059

SBR (SYNTH BRASS)

Synth Brass

No.	Name	Voice	Preset No.
129	3 Osc Brass	3	PR-E:060
130	Poly Brass	3	PR-A:068
131	P5 Polymod	2	PR-E:061
132	Brass It!	4	PR-C:010
133	Brass Attack	3	PR-C:011
134	Archimede	3	PR-C:012
135	Synergy Brs	4	XP-A:153
136	Rugby Horn	3	PR-C:013
137	MKS-80 Brass	2	PR-C:014
138	Synth Brass1	1	PR-D:063
139	Synth Brass2	2	PR-D:064
140	True ANALOG	2	PR-C:015
141	Afro Horns	3	PR-C:067
142	Breathy Brs	3	PR-E:059
143	Triumph Brs	3	PR-E:062
144	Octalog Hrn	2	XP-A:042

SAX (SAX) Sax

No.	Name	Voice	Preset No.
145	Soprano Sax	1	PR-D:065
146	Sop.Sax mf	2	PR-B:111
147	Alto Sax	3	PR-B:112
148	AltoLead Sax	3	PR-B:113
149	Alto Sax	1	PR-D:066
150	Super Tenor	3	XP-A:047
151	TenorExpress	2	XP-A:048
152	T.Sax f	1	XP-A:049
153	DEMO Tenor	3	XP-A:241
154	Tenor Sax	3	PR-B:114
155	Tenor Sax	1	PR-D:067
156	Baritone Sax	3	PR-B:115
157	Baritone Sax	2	PR-D:068
158	Soft Saxes	4	XP-A:040
159	Sax Section	4	PR-B:117
160	Bigband Sax	4	PR-B:118
161	Take A Tenor	4	PR-B:116
162	Sax Choir	4	PR-E:054

SYNTH/PAD (Synth/Pad Group)

HLD (HARD LEAD) Hard Synth Lead

No.	Name	Voice	Preset No.
001	Pulse Lead 1	1	PR-B:089
002	Little Devil	4	PR-B:091
003	Square Wave	2	PR-D:081
004	Sawteeth	3	PR-B:085
005	FXM Saw Lead	4	PR-B:084
006	Saw Wave	2	PR-D:082
007	Loud SynLead	4	PR-B:092
008	5th Saw Wave	3	PR-D:087
009	MG Solo	4	PR-B:083
010	MG Interval	4	PR-B:088
011	Eurotek Clav	2	XP-A:122
012	Progresso Ld	4	PR-E:089
013	Trangoa Wave	2	XP-A:130
014	Raw PWM	2	XP-A:213
015	5th Lead	2	PR-B:094
016	Wormy Lead	3	XP-A:209
017	Tweedles	2	XP-A:212
018	Edye Boost	2	PR-B:082
019	Adrenaline	4	PR-E:090
020	Analog Lead	2	PR-B:093
021	Buzzzzzzzzzzz	2	XP-A:125
022	On the move!	2	XP-A:172
023	Dirty Lead	2	XP-A:215
024	Charang	3	PR-D:085
025	Bass & Lead	2	PR-D:088

SLD (SOFT LEAD) Soft Synth Lead

No.	Name	Voice	Preset No.
026	SquareLead 1	3	PR-B:077
027	Syn.Calliope	2	PR-D:083
028	X...? Whistle	3	PR-E:087
029	Solo Vox	2	PR-D:086
030	Caliolead	3	XP-A:211
031	SquareLead 2	2	PR-B:078
032	Warm Pipe	1	PR-E:084
033	Atmo Lead	3	XP-A:210
034	Pure Pipe	2	PR-E:085
035	WhistlinAtom	2	PR-B:081
036	Belly Lead	4	PR-B:080
037	Smoothe	2	PR-B:086
038	You and Luck	2	PR-B:079
039	Pulse Lead 2	4	PR-B:090
040	MG Lead	2	PR-B:087
041	Chiffer Lead	4	PR-D:084
042	SH-2000	2	PR-E:086
043	Jay Vee Solo	3	PR-E:088
044	Voc Solo 5th	4	XP-A:214
045	DEMO SynLead 4		XP-A:252

TEK (TECHNO SYNTH) Techno Synth

No.	Name	Voice	Preset No.
046	Raver Circus	4	XP-A:162
047	Eurotek Brs	4	XP-A:152
048	DanceStack 1	3	XP-A:144
049	DanceStack 2	4	XP-A:145
050	DanceStack 3	4	XP-A:146
051	DanceStack 4	3	XP-A:147
052	DanceStack 5	4	XP-A:148
053	DanceStack 6	3	XP-A:149
054	DanceStack 8	4	XP-A:151
056	Big BPF	4	PR-C:103
057	Systemkno	4	XP-A:171
058	B'on d'moov!	3	PR-E:076
059	Mental Chord	4	PR-E:066
060	House Chord	4	PR-E:067
061	Auto TB-303	3	PR-B:048
062	Dist TB-303	2	PR-E:077
063	Resojuce	2	PR-E:075
064	Keep :-Åj	2	PR-E:074
065	Dope Resoclv	1	XP-A:123
066	Rezoid	4	PR-B:058
067	Tekno Juno	2	XP-A:124
068	Phazerave	2	XP-A:143
069	Tekno Square	3	XP-A:159
070	Raverborg	4	PR-B:059
071	Airplaaane	4	PR-B:100
072	Trance VoXxX	4	XP-A:160
073	TeknoSoloVox	2	PR-B:067
074	Random Rave	3	XP-A:161
075	Resorave	2	XP-A:163
076	Pick It	3	PR-B:064
077	House Piano	2	PR-A:007
078	Velo Tekno 2	2	PR-B:057
079	Analog Seq	2	PR-B:065
080	Sequalog	4	PR-E:068
081	Intentions	3	PR-B:063
082	Seq Mallet	2	PR-B:062
083	Plik-Plok	2	PR-E:071
084	Booster Bips	2	PR-E:069
085	VintagePlunk	4	PR-E:070
086	RingSequence	4	PR-E:072
087	Cyber Swing	4	PR-E:073
088	Hihat Tekno	2	PR-B:049
089	Impact Vox	4	PR-B:066
090	Techno Dream	3	PR-E:063
091	Organizer	3	PR-E:064
092	Civilization	3	PR-E:065
093	Velo Tekno 1	3	PR-B:050

PLS (PULSATING) Pulsating Synth

No.	Name	Voice	Preset No.
094	Alternative	2	PR-B:046
095	Acid Line	1	PR-B:047
096	Raggatronic	4	PR-B:051
097	Blade Racer	4	PR-B:052
098	S&H Pad	1	PR-B:053
099	Happy LFOs	4	XP-A:206
100	Syncrosnix	3	PR-B:054
101	Fooled Again	1	PR-B:055
102	Aero Insect	3	XP-A:207
103	Beat Sweeper	2	XP-A:208
104	Alive	3	PR-B:056
105	DEMO Insect	4	XP-A:253
106	X-Mod Man	2	PR-B:068
107	Paz <=> Zap	1	PR-B:069
108	Flying Waltz	4	PR-C:099
109	Strobe Mode	4	PR-C:093
110	Albion	2	PR-C:094
111	Planet Asia	4	PR-E:079
112	Afterlife	3	PR-E:080
113	Running Pad	4	PR-C:095
114	Pulsatronic	3	PR-E:082
115	Trancing Pad	2	PR-E:081
116	LFO Vox	1	PR-C:034
117	Cyber Dreams	3	PR-E:083
118	Stepped Pad	4	PR-C:096
119	Random Pad	4	PR-C:097
120	SoundtrkDANC	4	PR-C:098
121	Phazweep	4	PR-C:102
122	Goblin	2	PR-D:102
123	Temple of JV	4	PR-E:078
124	XP'ration	2	XP-A:173
125	DEMO SynPuls	2	XP-A:237

FX (SYNTH FX) Synth FX (Noise etc.)

No.	Name	Voice	Preset No.
126	Vanishing	1	PR-C:100
127	Shining Veil	3	XP-A:201
128	Vektogram	4	PR-C:109
129	Cascade	1	PR-C:112
130	Shattered	2	PR-C:113
131	Pure Tibet	1	PR-C:115
132	Sands ofTime	4	PR-C:107
133	NextFrontier	2	PR-C:114
134	Inertia	4	PR-C:108
135	RiversOfTime	4	PR-E:117
136	Atlantis2	4	XP-A:194
137	Rize Mass	3	XP-A:180
138	Glistening	4	PR-E:121
139	Perelandra	4	XP-A:195
140	Strepflanger	3	XP-A:205
141	Plutonium	4	XP-A:196
142	Metal Dreams	2	XP-A:198
143	Glass Clouds	4	XP-A:199
144	Portent	2	XP-A:181
145	Big Vectors	4	XP-A:185
146	DCO Sweeper	3	XP-A:182
147	Sweep Rain	4	XP-A:183
148	Sweep Stack	3	XP-A:184
149	Alchemy	3	XP-A:187
150	Striking 5th	4	XP-A:203
151	Meow 5ths	2	XP-A:204
152	Ethereal JX	2	XP-A:202
153	Harmoniccloud	4	XP-A:200
154	Feedback VOX	4	PR-C:111
155	Chime Wash	4	PR-C:116
156	Nautilus	2	XP-A:197
157	Creation	4	XP-A:227
158	Phobos	2	PR-E:118
159	Terminate	3	PR-C:128
160	2 0 8 0	4	PR-E:119
161	Crash Pad	4	PR-C:110
162	Tortured	4	PR-C:118
163	O-Zu-Nu	4	XP-A:165
164	Sci-Fi Str	3	PR-E:122
165	DelaySession	4	XP-A:118
166	Night Shade	4	PR-C:117
167	Uearthly	4	PR-E:120
168	Dunes	4	PR-C:120
169	Ice Hall	2	PR-C:125
170	Cyber Space	3	PR-C:122
171	Dissimilate	4	PR-C:119
172	Ocean Floor	1	PR-C:121
173	Helium Queen	4	PR-E:124
174	Shadows	4	PR-E:123
175	Boostsweeper1	2	XP-A:216
176	Boostsweeper2	2	XP-A:217
177	Biosphere	2	PR-C:123
178	ComputerRoom	4	PR-C:126
179	Cyberjunkie	4	XP-A:228
180	Sci-Fi FX x4	1	PR-E:125
181	Shine on	1	XP-A:230
182	Variable Run	4	PR-C:124
183	Sci-Fi Bells	3	XP-A:229
184	Inverted	4	PR-C:127
185	Breath Noise	2	PR-D:122

Patch Category List

SYNTH/PAD (Synth/Pad Group)

SYN (OTHER SYNTH)

Poly Synth

No.	Name	Voice	Preset No.
186	Poly Key	3	PR-A:062
187	Poly Saws	4	PR-A:063
188	Polysynth	2	PR-D:091
189	Poly Pulse	4	PR-A:064
190	Dual Profs	3	PR-A:065
191	Saw Mass	4	PR-A:066
192	Big Mess Pad	4	XP-A:140
193	Poly Split	4	PR-A:067
194	Poly Rock	4	PR-A:070
195	Puff 1080	2	PR-A:077
196	Stackoid	4	PR-A:069
197	Echo Juno	3	XP-A:142
198	Pulse Key	3	PR-A:089
199	Wire Pad	3	PR-E:026
200	Juno Harpsi	3	XP-A:139
201	PhaseBlipper	2	PR-E:027
202	Sweep Clav	3	PR-E:028
203	Isn't Pretty	3	XP-A:127
204	Polywasp	1	XP-A:128
205	Slop-a-rama	2	XP-A:126
206	Glider	2	PR-E:029
207	Spiked Cheez	3	XP-A:131
208	Glassy Cheez	3	XP-A:132
209	Lazerette	3	XP-A:175
210	Quixelate	4	XP-A:129
211	Super 808Cow	4	XP-A:133
212	Arpeggiatoid	4	XP-A:134
213	Brightness	3	PR-D:101
214	Fantasia	3	PR-D:089
215	Ice Rain	2	PR-D:097
216	JP6 Sqr Key	2	XP-A:109
217	Square drops	1	XP-A:110
218	Amazing Echo	4	XP-A:117
219	Str Torture	2	XP-A:138
220	PortaSynthex	3	XP-A:154
221	Razor VCOs	4	XP-A:155
222	Big PWM	2	XP-A:156
223	Flutey Stack	2	XP-A:157
224	Wobbly 5th	4	XP-A:158
225	Flangomatic	2	XP-A:164
226	Sub Divided	1	XP-A:166
227	Fat Flange	2	XP-A:168
228	Phaze NRG	1	XP-A:169
229	Big Ensemble	4	XP-A:174
230	Soli-na	2	XP-A:188
231	90s Str Mach	4	XP-A:189
232	Ancient Sqr	2	XP-A:167
233	Progressive	2	XP-A:192
234	Build-Up Syn	3	XP-A:193
235	DEMO Buzzzzz	2	XP-A:254

BPD (BRIGHT PAD)

Bright Pad Synth

No.	Name	Voice	Preset No.
236	Phazeslopad	4	XP-A:179
237	Jet Stack	4	XP-A:178
238	Combing Slow	3	XP-A:177
239	Spectrum Mod	4	PR-E:109
240	Stringsheen	3	PR-E:110
241	Mod DirtyWav	3	PR-E:112
242	Echo Drops	2	PR-D:103
243	5th Sweep	4	PR-C:101
244	Greek Power	4	PR-C:064
245	MG Sweep	4	PR-C:104
246	GR500 TmpDly	2	PR-E:111
247	Silicon Str	4	PR-E:113
248	Vintage Orch	4	PR-C:055
249	Gigantalog	4	PR-C:057
250	PWM Strings	3	PR-C:058
251	Ultra Cheez	2	XP-A:190
252	JUNO Strings	3	PR-C:056
253	JUNO Power!	4	PR-E:108
254	Pivotal Pad	4	PR-C:080
255	Fantawine	4	PR-C:082
256	Metal Pad	2	PR-D:094
257	Star Theme	2	PR-D:104
258	Harmonicum	2	PR-C:065
259	D-50 Heaven	2	PR-C:066
260	D50FantaPerc	3	PR-E:114
261	Heirborne	4	PR-C:073
262	Hush Pad	4	PR-C:074
263	Halo Pad	3	PR-D:095
264	Rotodreams	3	PR-E:115
265	Mahoroba	4	XP-A:121

SPD (SOFT PAD)

Soft Pad Synth

No.	Name	Voice	Preset No.
266	Earth Blow	2	PR-E:093
267	Square Pad	4	PR-C:070
268	JX SqrCarpet	2	PR-E:094
269	JP-8 Hollow	4	PR-C:071
270	JP-8Haunting	4	PR-C:072
271	Silky Way	2	PR-E:099
272	Rich Dynapad	4	PR-E:098
273	Warm Pad	2	PR-D:090
274	Warmth	2	PR-C:059
275	Pop Pad	4	PR-C:068
276	Gluey Pad	3	PR-E:100
277	ORBit Pad	2	PR-C:060
278	Syn.Strings1	2	PR-D:051
279	Syn.Strings2	2	PR-D:052
280	Juno-60 Pad	3	XP-A:191
281	Octapad	3	PR-E:107
282	Poly Swell	2	XP-A:186
283	E-Motion Pad	4	PR-C:053
284	Translucence	4	PR-E:103
285	Glassy Pad	3	PR-C:083
286	Glass Blower	3	PR-E:092
287	Dreamesque	4	PR-C:069
288	Moving Glass	1	PR-C:084
289	D'light	2	PR-E:105
290	Glasswaves	3	PR-C:085
291	ShiftedGlass	2	PR-C:087
292	Bowed Glass	3	PR-D:093
293	December Sky	4	PR-E:106
294	Pulse Pad	4	PR-C:063
295	Pulsify	4	PR-C:062
296	Shiny Pad	4	PR-C:086
297	Analog Drama	3	PR-E:097
298	BandPass Mod	2	PR-E:101
299	Dimensional	2	PR-E:095
300	Phaze Str	4	PR-C:078
301	Jupiterings	2	PR-E:096
302	Fazed String	4	XP-A:176
303	Jet Str Ens	2	PR-C:079
304	Phaze Pad	3	PR-C:077
305	Jet Pad 1	2	PR-C:075
306	Jet Pad 2	2	PR-C:076
307	Sweep Pad	2	PR-D:096
308	3D Flanged	1	PR-C:081
309	Dawn 2 Dusk	3	PR-C:091
310	Aurora	4	PR-C:092
311	Chime Pad	3	PR-C:088
312	Spin Pad	2	PR-C:089
313	Rotary Pad	4	PR-C:090
314	Soundtrack	2	PR-D:098
315	Soundtraque	2	PR-E:102
316	Darkshine	4	PR-E:104
317	DEMO 5thPad	4	XP-A:238

VOX (VOX)

Vox, Choir

No.	Name	Voice	Preset No.
318	Dark Vox	2	PR-C:016
319	Angels Sing	2	PR-C:018
320	Beauty Vox	3	PR-C:022
321	Pvox Oooze	3	PR-C:019
322	Dream Voices	2	XP-A:023
323	SynVox	1	PR-D:055
324	RandomVowels	4	PR-C:017
325	Choir Aahs	3	PR-D:053
326	Enlighten	4	PR-E:091
327	Longing...	3	PR-C:020
328	Arasian Morn	4	PR-C:021
329	Mary-AnneVox	4	PR-C:023
330	Belltree Vox	4	PR-C:024
331	Vox Panner	2	PR-C:025
332	Glass Voices	3	PR-C:027
333	Tubular Vox	4	PR-C:028
334	Space Voice	2	PR-D:092
335	PercussiVox	4	XP-A:029
336	Wavox	3	PR-C:030
337	Velo Voxx	2	PR-C:029
338	Vocal Oohz	3	PR-C:033
339	Spaced Voxx	4	PR-C:026
340	Phase Mmhs	3	XP-A:031
341	Mysteriouso	3	XP-A:030
342	Ivory Mist	4	XP-A:028
343	AmbientStory	4	XP-A:032
344	Venus	3	XP-A:033
345	Phase Vox	3	XP-A:170
346	Doos	1	PR-C:031
347	Voice Oohs	1	PR-D:054
348	Synvox Comps	4	PR-C:032
349	Chorale	1	XP-A:025
350	Str+Choir3	4	XP-A:021
351	Space Men	3	XP-A:026
352	DEMO Choir	2	XP-A:239
353	Breathy Humz	2	XP-A:022
354	Mmmms	2	XP-A:024
355	Choir Mm+Aah	4	XP-A:027

ETHNIC (Ethnic Group)

PLK (PLUCKED) Plucked (Harp etc.)

No.	Name	Voice	Preset No.
001	Sitar	2	PR-A:101
002	Drone Split	4	PR-A:102
003	Sitar	1	PR-D:105
004	Dulcimer	2	PR-A:105
005	Santur	2	PR-D:016
006	East Europe	2	PR-E:040
007	Dulcitar	4	PR-E:041
008	Harp On It	3	PR-C:049
009	Harp	2	PR-C:050
010	Harp	2	PR-D:047
011	Atmos Harp	4	PR-E:042
012	Shamisen	2	PR-D:107
013	Jamisen	2	PR-A:104
014	Koto	1	PR-D:108
015	Ethnopluck	4	PR-A:103
016	Kalimba	1	PR-D:109
017	Pilgrimage	4	PR-E:043

ETH (ETHNIC) Other Ethnic

No.	Name	Voice	Preset No.
018	Shakuhachi	1	PR-D:078
019	Taj Mahal	1	PR-B:101
020	Raya Shaku	3	PR-B:102
021	Shanai	1	PR-D:112
022	Bag Pipe	3	PR-D:110
023	French Bags	4	PR-B:123
024	East Melody	2	PR-A:106
025	Far East	4	PR-E:025

FRT (FRETTED) Fretted Inst (Mandolin etc.)

No.	Name	Voice	Preset No.
026	MandolinTrem	4	PR-A:107
027	Banjo	1	PR-D:106

RHYTHM&SFX (Rhythm & Sound Effects Group)

PRC (PERCUSSION) Percussion

No.	Name	Voice	Preset No.
001	CeremonyTimp	3	PR-C:105
002	Timpani	1	PR-D:048
003	Dyno Toms	4	PR-C:106
004	Melo. Tom 1	2	PR-D:118
005	Taiko	4	PR-D:117
006	Agogo	1	PR-D:114
007	Woodblock	1	PR-D:116
008	Synth Drum	2	PR-D:119
009	Reverse Cym.	2	PR-D:120
010	Perky Noize	3	PR-E:126

SFX (SOUND FX) Sound Effects

No.	Name	Voice	Preset No.
011	Seashore	3	PR-D:123
012	Seashore 2	4	XP-A:226
013	Bird	4	PR-D:124
014	Telephone 1	1	PR-D:125
015	Helicopter	2	PR-D:126
016	Applause	4	PR-D:127
017	DEMO Crowd	4	XP-A:255
018	Gun Shot	2	PR-D:128
019	Droplet	3	PR-E:127
020	Rain Forest	4	PR-E:128
021	Analog Bomb	2	XP-A:225

BTS (BEAT&GROOVE) Beat and Groove

--- No assign

DRM (DRUMS) Drum Set

--- No assign

CMB (COMBINATION) Other Patches which use Split and Layer

No.	Name	Voice	Preset No.
022	Blue Notes	4	PR-E:116
023	Lounge Gig	3	PR-A:117
024	Bs/Pno+Brs	4	PR-A:013
025	Hillbillys	4	PR-B:122

Rhythm Set List

	USER (User)		PR-A (Preset A Group)		PR-B (Preset B Group)	
	001	002	001	002	001	002
Note No.	HouseDrumSet 1	JazzDrumSet1	PopDrumSet 1	PopDrumSet 2	PowerDrumSet	RaveDrumSet
	Scratch 1	Hybrid Kick2	Verb Kick	Hybrid Kick1	Verb Kick	808 Kick
C2 36	808 SN	Hybrid Kick1	Hybrid Kick1	Round Kick	Round Kick	Round Kick
37	Dry Stick	Side Stick	Side Stick	Dry Stick	Dry Stick	Side Stick
38	808 SN	Ballad SN	Natural SN2	Piccolo SN	Piccolo SN	808 SN
39	808 Claps	Brush Slap	808 Claps	Hand Claps	808 Claps	808 Claps
40	808 SN	Brush Swish	SN Roll	Piccolo SN	Natural SN2	808 SN
41	808 Kick	Verb Tom Lo	Verb Tom Lo	Verb Tom Lo	Verb Tom Lo	808 Kick
42	606 HiHat Cl	Cl HiHat 1	Cl HiHat 1	Cl HiHat 1	Cl HiHat 1	606 HiHat Cl
43	808 SN	Verb Tom Lo	Verb Tom Lo	Verb Tom Lo	Verb Tom Lo	Tekno Hit
44	606 HiHat Cl	Pedal HiHat	Cl HiHat 2	Cl HiHat 2	Pedal HiHat	606 HiHat Cl
45	808 Kick	Verb Tom Hi	Verb Tom Hi	Verb Tom Hi	Verb Tom Lo	808 Kick
46	606 HiHat Op	Op HiHat	Op HiHat	Op HiHat	Op HiHat	606 HiHat Op
47	808 SN	Verb Tom Hi	Verb Tom Hi	Verb Tom Hi	Verb Tom Lo	Tekno Hit
C3 48	808 Kick	Verb Tom Hi	Verb Tom Hi	Verb Tom Hi	Verb Tom Hi	808 Kick
49	Crash 1	Crash 1	Crash 1	Crash 1	Crash 1	Crash 1
50	808 SN	Verb Tom Hi	Verb Tom Hi	Verb Tom Hi	Verb Tom Hi	Tekno Hit
51	Ride 2	Ride 2	Ride 2	Ride 1	Ride 1	Voice Breath
52	REV Crash 1	China Cym	China Cym	China Cym	China Cym	MC500 Beep 1
	Ride Bell 1	Ride Bell 1	Ride Bell 1	Ride Bell 1	Ride Bell 1	MC500 Beep 2
53	Tambourine	Tambourine	Tambourine	Tambourine	Tambourine	R8 Click
54	Crash 1	Crash 1	Crash 1	Crash 1	Crash 1	Pizz
55	Cowbell 1	Cowbell 1	Cowbell 1	Cowbell 1	Cowbell 1	DIGI Bell 1
56	Crash 1	Crash 1	Crash 1	Crash 1	Crash 1	Rattles
57	Vibraslap	Vibraslap	Cowbell 1	Cowbell 1	Vibraslap	Ride Bell 1
58	Ride 2	Ride 2	Ride Bell 1	Ride Bell 1	Ride 1	REV Tamb
C4 60	Bongo Hi	Bongo Hi	Cga Mute Hi	Cga Mute Hi	Bongo Hi	2.2 Vibwave
61	Bongo Lo	Bongo Lo	Cga Mute Lo	Cga Mute Lo	Bongo Lo	Low Pink NZ
62	Cga Mute Hi	Cga Mute Hi	Cga Slap	Cga Slap	Cga Mute Hi	Kalimba
63	Cga Open Hi	Cga Open Hi	Cga Open Hi	Cga Open Hi	Cga Open Hi	Metal Wind
64	Cga Open Lo	Cga Open Lo	Cga Open Lo	Cga Open Lo	Cga Open Lo	Lead Wave
65	Timbale	Timbale	Timbale	Timbale	Timbale	Tin Wave
66	Timbale	Timbale	Timbale	Timbale	Timbale	Agogo
67	Agogo	Agogo	Agogo	Agogo	Agogo	Lite Kick
68	Agogo	Agogo	Agogo	Agogo	Agogo	Agogo
69	Cabasa Cut	Cabasa Up	Cabasa Up	Cabasa Up	Cabasa Up	Lite Kick
70	Maracas	Maracas	Maracas	Maracas	Maracas	Agogo
71	Soft Pad B	Soft Pad B	Soft Pad A	Cabasa Down	Soft Pad A	Gtr Harm A
C5 72	Soft Pad A	Soft Pad A	Soft Pad B	Cabasa Cut	Soft Pad B	Gtr Harm A
73	Long Guiro	Long Guiro	Long Guiro	808 Kick	Long Guiro	Piano Thump
74	Long Guiro	Long Guiro	Long Guiro	808 SN	Long Guiro	Natural SN
75	Claves	Claves	Claves	DIGI Bell 1	Claves	Hand Claps
76	Wood Block	Wood Block	Wood Block	808 SN	Wood Block	Natural SN1
77	Wood Block	Wood Block	Wood Block	808 Kick	Wood Block	808 SN
78	Cuica	Cuica	Cuica	Spectrum	Cuica	PowerChord B
79	Cuica	Cuica	Cuica	808 Kick	Cuica	Hybrid Kick2
80	Open Triangl	Open Triangl	Open Triangl	Spectrum	Open Triangl	PowerChord B
81	Open Triangl	Open Triangl	Open Triangl	808 Kick	Open Triangl	Gt.FretNoise
82	Cabasa Cut	Cabasa Cut	Cabasa Cut	Spectrum	Maracas	Banjo B
83	Tambourine	Spectrum	Spectrum	808 Kick	Ice Rain	Slap Bass 1
C6 84	Old Kick	Wind Chimes	Wind Chimes	808 Kick	Wind Chimes	Oboe mf A
85	Scratch 1	Wood Block	Wood Block	Feedbackwave	Claves	Shakuhachi
86	Piccolo SN	Cga Slap	Cga Slap	808 Kick	808 SN	Pizz
87	Scratch 3	Dry Tom Lo	Dry Tom Lo	Feedbackwave	Verb Tom Hi	Syn Vox 1
88	White Noise	Lite Kick	Lite Kick	Pop Voice	Piccolo SN	Voice Aahs A
	Synth Saw 1	Hybrid Kick2	Hybrid Kick2	Pop Voice	Scratch 3	Voice Oohs2A
89	Synth Pulse1	Old Kick	Old Kick	Wind Agogo	Tin Wave	Pop Voice
90	Back Hit	808 Kick	Pop Voice	Pop Voice	Spectrum	Male Ooh A
91	Tekno Hit	Natural SN1	Wind Agogo	Wind Agogo	REV Steel DR	Voice Breath
92	Orch. Hit	Natural SN2	Op HiHat	Op HiHat	REV Tin Wave	Org Vox C
93	Philly Hit	SN Roll	Anklungs	Anklungs	REV PiccloSN	Vox Noise
94	REV Back Hit	Natural SN2	Op HiHat	Op HiHat	REV Crash 1	Vox Noise
95	MC500 Beep 1	Metronome 2	Metronome 2	Metronome 2	Metronome 2	Applause
C7 96	R8 Click	R8 Click	R8 Click	R8 Click	R8 Click	R8 Click
97	MC500 Beep 2	Metronome 1	Metronome 1	Metronome 1	Metronome 1	Metronome 2
98						

		PR-C (Preset C Group)		PR-D (GM Group)		PR-E (Preset E Group)	
		001	002	001	002	001	002
Note No.		JazzDrumSet2	OrchDrumSet	GM Drum Set	BrushDrumSet	PowerDrmSet2	PowerRaveSet
C2	35	Round Kick	Old Kick	Verb Kick	Hybrid Kick2	Verb Kick	Verb Kick
	36	Old Kick	Round Kick	Hybrid Kick1	Hybrid Kick1	Round Kick	Round Kick
	37	Side Stick	Side Stick	Side Stick	Side Stick	Dry Stick	Dry Stick
	38	Ballad SN	Ballad SN	Ballad SN	Brush Swish	Piccolo SN	Piccolo SN
	39	Hand Claps	808 Claps	808 Claps	Brush Slap	808 Claps	808 Claps
	40	SN Roll	SN Roll	Piccolo SN	Brush Roll	SN Roll	Natural SN2
	41	Verb Tom Lo	Timpani	Verb Tom Lo	Dry Tom Lo	Verb Tom Lo	Verb Tom Lo
	42	CI HiHat 2	Timpani	CI HiHat 1	CI HiHat 1	CI HiHat 1	CI HiHat 1
	43	Dry Tom Lo	Timpani	Verb Tom Lo	Dry Tom Lo	Verb Tom Lo	Verb Tom Lo
	44	Pedal HiHat	Timpani	Pedal HiHat	Pedal HiHat	Pedal HiHat	Pedal HiHat
	45	Verb Tom Lo	Timpani	Verb Tom Hi	Dry Tom Hi	Verb Tom Lo	Verb Tom Lo
	46	Op HiHat	Timpani	Op HiHat	Op HiHat	Op HiHat	Op HiHat
	47	Dry Tom Lo	Timpani	Verb Tom Hi	Dry Tom Hi	Verb Tom Lo	Verb Tom Lo
C3	48	Verb Tom Hi	Timpani	Verb Tom Hi	Dry Tom Hi	Verb Tom Hi	Verb Tom Hi
	49	Crash 1	Timpani	Crash 1	Crash 1	Crash 1	Crash 1
	50	Dry Tom Hi	Timpani	Verb Tom Hi	Dry Tom Hi	Verb Tom Hi	Verb Tom Hi
	51	Ride 2	Timpani	Ride 2	Ride 2	Ride 1	Ride 1
	52	China Cym	Timpani	China Cym	China Cym	China Cym	China Cym
	53	Ride Bell 1	Timpani	Ride Bell 1	Ride Bell 1	Ride Bell 1	Ride Bell 1
	54	Tambourine	Tambourine	Tambourine	Tambourine	Tambourine	Tambourine
	55	Crash 1	Crash 1	Crash 1	Crash 1	Crash 1	Crash 1
	56	Cowbell 1	Cowbell 1	Cowbell 1	Cowbell 1	Cowbell 1	Cowbell 1
	57	Crash 1	Crash 1	Crash 1	Crash 1	Crash 1	Crash 1
	58	Vibraslap	Ride 1	Vibraslap	Vibraslap	Vibraslap	Vibraslap
	59	Ride 2	Ride 2	Ride 2	Ride 2	Ride 1	Ride 1
C4	60	Bongo Hi	Bongo Hi	Bongo Hi	Cga Mute Hi	Bongo Hi	Bongo Hi
	61	Bongo Lo	Bongo Lo	Bongo Lo	Cga Mute Lo	Bongo Lo	Bongo Lo
	62	Cga Mute Hi	Cga Mute Hi	Cga Mute Hi	Cga Slap	Cga Mute Hi	Cga Mute Hi
	63	Cga Open Hi	Cga Open Hi	Cga Open Hi	Cga Open Hi	Cga Open Hi	Cga Open Hi
	64	Cga Open Lo	Cga Open Lo	Cga Open Lo	Cga Open Lo	Cga Open Lo	Cga Open Lo
	65	Timbale	Timbale	Timbale	Timbale	Timbale	Timbale
	66	Timbale	Timbale	Timbale	Timbale	Timbale	Timbale
	67	Agogo	Agogo	Agogo	Agogo	Agogo	Agogo
	68	Agogo	Agogo	Agogo	Agogo	Agogo	Agogo
	69	Cabasa Up	Cabasa Up	Cabasa Up	Cabasa Up	Cabasa Up	Agogo
	70	Maracas	Maracas	Maracas	Maracas	Maracas	Maracas
	71	Soft Pad A	Soft Pad A	Soft Pad A	Soft Pad A	Soft Pad A	606 HiHat Cl
C5	72	Brush Swish	Soft Pad B	Soft Pad B	Soft Pad B	Soft Pad B	606 HiHat Cl
	73	Long Guiro	Long Guiro	Long Guiro	Long Guiro	Long Guiro	606 HiHat Op
	74	Long Guiro	Long Guiro	Long Guiro	Long Guiro	Long Guiro	Long Guiro
	75	Claves	Claves	Claves	Claves	Claves	Claves
	76	Wood Block	Wood Block	Wood Block	Wood Block	Wood Block	Wood Block
	77	Metronome 2	Wood Block	Wood Block	Wood Block	Wood Block	Wood Block
	78	Cuica	Cuica	Cuica	Cuica	Cuica	Pizz
	79	Cuica	Cuica	Cuica	Cuica	Cuica	Syn Vox 1
	80	Open Triangl	Open Triangl	Open Triangl	Open Triangl	Open Triangl	Voice Aahs A
	81	Open Triangl	Open Triangl	Open Triangl	Open Triangl	Open Triangl	Voice Oohs2A
	82	Cabasa Cut	Cabasa Cut	Cabasa Cut	Cabasa Cut	Maracas	Male Ooh A
	83	Spectrum	Spectrum	Spectrum	Spectrum	Ice Rain	Ice Rain
C6	84	Wind Chimes	Wind Chimes	Wind Chimes	Wind Chimes	Wind Chimes	808 SN
	85	Wood Block	Wood Block	Wood Block	Wood Block	Claves	808 SN
	86	Cga Slap	Cga Slap	Cga Slap	Cga Slap	808 SN	808 SN
	87	Dry Tom Lo	Dry Tom Lo	Dry Tom Lo	Dry Tom Lo	Verb Tom Hi	Hand Claps
	88	Lite Kick	Applause	Lite Kick	Lite Kick	Piccolo SN	Voice Breath
	89	Hybrid Kick2	Hybrid Kick2	Hybrid Kick2	Hybrid Kick2	Scratch 3	Scratch 3
	90	Old Kick	CI HiHat 1	Old Kick	Old Kick	Tin Wave	Tin Wave
	91	Natural SN2	Round Kick	808 Kick	808 Kick	Spectrum	Crash 1
	92	Natural SN1	Pedal HiHat	Natural SN1	Natural SN1	REV Steel DR	Ride Bell 1
	93	Brush Swish	Natural SN2	Natural SN2	Natural SN2	REV Tin Wave	REV Tin Wave
	94	Brush Roll	Op HiHat	808 SN	SN Roll	REV PiccloSN	DIGI Bell 1
	95	Brush Slap	Brush Slap	Brush Slap	Brush Slap	REV Crash 1	Metal Wind
C7	96	Metronome 2	Brush Swish	Brush Swish	Metronome 2	Metronome 2	Applause
	97	R8 Click	Brush Roll	Brush Roll	R8 Click	R8 Click	R8 Click
	98	Metronome 1	SN Roll	SN Roll	Metronome 1	Metronome 1	Metronome 1

Rhythm Set List

XP-A (Session)

Note No.	001 SessionSet 1	002 SessionSet 2	003 SessionSet 3	004 SessionSet 4	005 SessionSet 5	006 SessionSet 6	007 SessionSet 7	008 Demo Drum
C2 35	Deep Kick 3	Mix Kick	Deep Kick 3	Dance Kick 2	Kick Ghost	Dance Kick 3	Deep Kick 3	Old Kick
36	Mix Kick	Deep Kick 3	TD7 Kick	Dance Kick 3	Dance Kick 3	Dance Kick 2	Mix Kick	Hybrid Kick1
37	Side Stick	Side Stick	Side Stick	909 Rim 2	909 Rim 2	Mute Snr	Side Stick	Side Stick
38	Solo Snr	Loose Snr	Rap Snr	909 Snr 2	909 Snr 3	Jingle Snr	Solo Snr	Loose Snr
39	HC2 Claps 1	HC2 Claps 1	707 Claps	909 Claps 2	HC2 Claps 2	HC2 Claps 2	707 Claps	Tambrin MENU
40	90's Snare	Ring Snr	House Snr	808 Snr 2	Talk Snr	Tiny Snr 2	Ring Snr	Natural SN2
41	Verb Tom Lo	Verb Tom Lo	Verb Tom Lo	909 Tom 2	909 Tom 2	909 Tom 2	909 Tom 2	Verb Tom Lo
42	CI HiHat 1	CI HiHat 1	CI HiHat 1	606 HiHat Cl	606 HiHat Cl	606 HiHat Cl	606 HiHat Cl	CI HiHat 1
43	Verb Tom Lo	Verb Tom Lo	Verb Tom Lo	Verb Tom Lo	Verb Tom Lo	Verb Tom Lo	Verb Tom Lo	Verb Tom Lo
44	CI HiHat 2	CI HiHat 2	CI HiHat 2	606 HiHat Op	606 HiHat Op	606 HiHat Op	606 HiHat Cl	Pedal HiHat
45	Verb Tom Hi	Verb Tom Hi	Verb Tom Hi	909 Tom 2	909 Tom 2	909 Tom 2	909 Tom 2	Verb Tom Hi
46	Op HiHat	Op HiHat	Op HiHat	606 HiHat Op	606 HiHat Op	606 HiHat Op	606 HiHat Op	Op HiHat
47	Verb Tom Hi	Verb Tom Hi	Verb Tom Hi	Verb Tom Hi	Verb Tom Hi	Verb Tom Hi	Verb Tom Hi	Verb Tom Hi
C3 48	Verb Tom Hi	Verb Tom Hi	Verb Tom Hi	909 Tom 2	909 Tom 2	909 Tom 2	909 Tom 2	Verb Tom Hi
49	Crash 1	Crash 1	Crash 1	Crash 1	Crash 1	Crash 1	Crash 1	Crash 1
50	Verb Tom Hi	Verb Tom Hi	Verb Tom Hi	Verb Tom Hi	Verb Tom Hi	Verb Tom Hi	Verb Tom Hi	Verb Tom Hi
51	Ride 2	Ride 2	Ride 2	Ride 2	Ride 2	Ride 2	Ride 2	Ride 1
52	China Cym	China Cym	China Cym	China Cym	China Cym	China Cym	China Cym	China Cym
53	Ride Bell 1	Ride Bell 1	Ride Bell 1	Ride Bell 1	Ride Bell 1	Ride Bell 1	Ride Bell 1	Ride Bell 1
54	Tamb.Long	Tamb.Long	Tamb.Long	CR78 Tamb.	CR78 Tamb.	CR78 Tamb.	CR78 Tamb.	Tamb.Long
55	Crash 1	Crash 1	Crash 1	Crash 1	Crash 1	Crash 1	Crash 1	Crash 1
56	Cowbell 1	Cowbell 1	Cowbell 1	Cowbell 1	Cowbell 1	Cowbell 1	Cowbell 1	Cowbell 1
57	Crash 1	Crash 1	Crash 1	Crash 1	Crash 1	Crash 1	Crash 1	Crash 1
58	Cowbell 1	Cowbell 1	Cowbell 1	Cowbell 1	Cowbell 1	Cowbell 1	Cowbell 1	Vibraslap
59	Ride Bell 1	Ride Bell 1	Ride Bell 1	Ride Bell 1	Ride Bell 1	Ride Bell 1	Ride Bell 1	Ride 2
C4 60	Bongo3 High	Bongo3 High	Bongo3 High	Bongo3 High	Bongo3 High	Bongo3 High	Bongo3 High	Bongo Hi
61	Bongo3 Low	Bongo3 Low	Bongo3 Low	Bongo3 Low	Bongo3 Low	Bongo3 Low	Bongo3 Low	Bongo Lo
62	Cga Slap	Cga Slap	Cga Slap	Cga Slap	Cga Slap	Cga Slap	Cga Slap	Cga Mute Hi
63	Cga Open Hi	Cga Open Hi	Cga Open Hi	Cga Open Hi	Cga Open Hi	Cga Open Hi	Cga Open Hi	Cga Open Hi
64	Cga Open Lo	Cga Open Lo	Cga Open Lo	Cga Open Lo	Cga Open Lo	Cga Open Lo	Cga Open Lo	Cga Open Lo
65	Timbale	Timbale	Timbale	Timbale	Timbale	Timbale	Timbale	Timbale
66	Timbale	Timbale	Timbale	Timbale	Timbale	Timbale	Timbale	Timbale
67	Agogo	Agogo	Agogo	Agogo	Agogo	Agogo	Agogo	Agogo
68	Agogo	Agogo	Agogo	Agogo	Agogo	Agogo	Agogo	Agogo
69	Shaker 4	Shaker 4	Shaker 4	Shaker 4	626 Shaker	626 Shaker	626 Shaker	Cabasa Up
70	Shaker 5	Shaker 5	Shaker 5	Shaker 5	Shaker 4	Shaker 4	Shaker 4	Maracas
71	Soft Pad A	Soft Pad A	Soft Pad A	Soft Pad A	Soft Pad A	Soft Pad A	Soft Pad A	Soft Pad A
C5 72	Soft Pad B	Soft Pad B	Soft Pad B	Soft Pad B	Soft Pad B	Soft Pad B	Soft Pad B	Soft Pad B
73	Long Guiro	Long Guiro	Long Guiro	Long Guiro	Long Guiro	Long Guiro	Long Guiro	Long Guiro
74	Long Guiro	Long Guiro	Long Guiro	Long Guiro	Long Guiro	Long Guiro	Long Guiro	Long Guiro
75	Claves	Claves	Claves	Claves	Claves	Claves	Claves	Claves
76	Wood Block	Wood Block	Wood Block	Wood Block	Wood Block	Wood Block	Wood Block	Wood Block
77	Wood Block	Wood Block	Wood Block	Wood Block	Wood Block	Wood Block	Wood Block	Wood Block
78	Cuica	Cuica	Cuica	Cuica	Cuica	Cuica	Cuica	Shaker 3
79	Cuica	Cuica	Cuica	Cuica	Cuica	Cuica	Cuica	Cuica
80	Open Triangl	Open Triangl	Open Triangl	Open Triangl	Open Triangl	Open Triangl	Open Triangl	606 HiHat Cl
81	Open Triangl	Open Triangl	Open Triangl	Open Triangl	Open Triangl	Open Triangl	Open Triangl	Open Triangl
82	Cabasa Cut	Cabasa Cut	Cabasa Cut	Cabasa Cut	Cabasa Cut	Cabasa Cut	Cabasa Cut	606 HiHat Op
83	Auhvox	Auhvox	REV Gt Scrap	Auhvox	Auhvox	Auhvox	REV Shaker 5	Ride 2
C6 84	Tekno Hit 3	Gtr Feedback	REV Gt SlidNz	Tekno Hit 3	Tekno Hit 3	Tekno Hit 3	REV Shaker 4	Dance Kick 2
85	Tekno Hit 3	Gtr Scrap	REV Gt CutNz	Tekno Hit 3	Tekno Hit 3	Tekno Hit 3	REV Shaker 3	Dance Kick 2
86	Tekno Hit 2	Gtr Slid Nz	REV Gt Slap	Tekno Hit 2	Tekno Hit 2	Tekno Hit 2	REV 626Shakr	House Snr
87	Tekno Hit 2	Gtr Cut Nz	REV TeknHit2	Tekno Hit 2	Tekno Hit 2	Tekno Hit 2	REV CR78Tamb	Tiny Snr 2
88	FX Bell 2fw	Gtr Slap	REV TeknHit3	FX Bell 2fw	REV Dance K3	Tekno Loop	REV Tamb.Lng	Tiny Snr 2
89	FX Bell 1fw	Wah Down 1	REV Dance K3	FX Bell 1fw	REV TeknHit3	REV TeknHit3	REV Tamb.Sht	Hybrid Kick2
90	FX Bomb	Wah Up 1	REV 909 Snr2	FX Bomb	REV TeknHit3	REV TeknHit3	REV Bongo3 H	Old Kick
91	Sm.Club fw	Wah Down 2	REV 909 Snr3	Sm.Club fw	REV TeknHit2	REV TeknHit2	REV Bongo3 L	Dance Kick 2
92	HC2 Claps 2	Wah Up 2	REV Rap Snr	HC2 Claps 2	REV TeknHit2	REV TeknHit2	REV F.Snap 3	Loose Snr
93	Gtr Scrap	Sm.Club	REV Talk Snr	FingerSnaps2	REV 808 Snr2	Blaster A	REV F.Snaps2	Natural SN2
94	707 Claps	Sm.Club fw	REV JnglSnr	707 Claps	REV 909 Snr2	Juno Rave A	REV HC2 Clp2	Tiny Snr 2
95	Gtr Slid Nz	FX Bell 1fw	REV HouseSnr	626 Shaker	REV 909 Snr3	Hard 5ths A	REV 707 Clps	Wind Chimes
C7 96	Gtr Cut Nz	FX Bell 2fw	REV Mute Snr	Tamb.Short	REV HC2 Clp1	CR78 Tamb.	REV HC2 Clp1	Dry Tom Lo
97	R8 Click	R8 Click	R8 Click	R8 Click	R8 Click	R8 Click	R8 Click	Piccolo SN
98	Gtr Slap	REV Snr Buzz	REV 909 Rim2	Tamb.Long	REV 707 Clps	FingerSnap 3	REV 909 Clp2	Dry Tom Lo

Performance List

USER (User Group)

No.	Name	Key Mode
01	EasternSplit	LAYER
02	Opening Orch	LAYER
03	Feedback EP	LAYER
04	Humming Vox	LAYER
05	Tekno Loop 1	LAYER
06	Fr.Horn Sect	LAYER
07	SpaceCarrier	LAYER
08	Orchestral	LAYER
09	Nebular Vox	LAYER
10	Terminator	LAYER
11	Flying Jazz	LAYER
12	Sweeper	LAYER
13	Rave Split	LAYER
14	Multi Sax	LAYER
15	Cosmic Dawn	LAYER
16	Bass / Lead	LAYER
17	S&H / Pad	LAYER
18	AcPiano+Pad	LAYER
19	Kicks Attack	LAYER
20	Step Brass	LAYER
21	Drone / Pipe	LAYER
22	Chime Dreams	LAYER
23	Tekno Loop 2	LAYER
24	Big Band	LAYER
25	Labyrinth	LAYER
26	White Hole	LAYER
27	Cyber Sweep	LAYER
28	Tekno Asia	LAYER
29	1080 Fantasy	LAYER
30	Pop Ballad	LAYER
31	Rhythmic	LAYER
32	Power JV	LAYER

PR-A (Preset A Group)

No.	Name	Key Mode
01	House Set	SINGLE
02	Analectro	SINGLE
03	Anatronic	SINGLE
04	Tekno Pop 1	SINGLE
05	Tekno Pop 2	SINGLE
06	Hard Core	SINGLE
07	Hi Energy	SINGLE
08	Pop Dance	SINGLE
09	Acid Set	SINGLE
10	Ambient Set	SINGLE
11	Electro Pop	SINGLE
12	Pop Set 1	SINGLE
13	Pop Set 2	SINGLE
14	Pop Set 3	SINGLE
15	Pop Set 4	SINGLE
16	L.A. Ballad	SINGLE
17	Hip Hop Set	SINGLE
18	Funk Rock	SINGLE
19	Funk Fusion	SINGLE
20	Heavy Metal	SINGLE
21	Heavy Kids	LAYER
22	Latin Set	SINGLE
23	BrazilianSet	SINGLE
24	New Age 1	SINGLE
25	New Age 2	SINGLE
26	Orchestra	SINGLE
27	Concerto	SINGLE
28	Film Score 1	SINGLE
29	Film Score 2	SINGLE
30	Symphonic	SINGLE
31	Chamber Set	SINGLE
32	Baroque Set	SINGLE

PR-B (Preset B Group)

No.	Name	Key Mode
01	Africa	SINGLE
02	World Ethnic	SINGLE
03	Asian Ethnic	SINGLE
04	Asian Band	SINGLE
05	60's Set	SINGLE
06	Blues Band	SINGLE
07	Country Band	SINGLE
08	Folk Set	SINGLE
09	Reggae Band	SINGLE
10	FunkWah Band	SINGLE
11	Funkin'Phaze	SINGLE
12	Zydeco Band	SINGLE
13	New Orleans	SINGLE
14	Dixieland	SINGLE
15	Big Band Set	SINGLE
16	Cont.Jazz 1	SINGLE
17	Cont.Jazz 2	SINGLE
18	Ac.Jazz Set	SINGLE
19	Gospel Set	SINGLE
20	All Strings	SINGLE
21	All Brass	SINGLE
22	All Piano 1	SINGLE
23	All Piano 2	SINGLE
24	All Keyboard	SINGLE
25	All Organ	SINGLE
26	All Winds	SINGLE
27	All Bells	LAYER
28	Mlt & Perc	SINGLE
29	All Seq	SINGLE
30	All Bass	SINGLE
31	All Pad	SINGLE
32	All FX	SINGLE

MIDI Implementation

Model: JV-1010 (64 Voice Synthesizer Module)
Version: 1.00
Date: Jan. 28 1999

1. Data Reception

■ Channel Voice Messages

● Note Off

status	2nd byte	3rd byte
8nH	kkH	vvH
9nH	kkH	00H

n=MIDI channel number: 0H - FH (ch.1 - ch.16)
kk=note number: 00H - 7FH (0 - 127)
vv=Note Off velocity: 00H - 7FH (0 - 127)

- * Not received in Performance mode when the Receive Switch (PERFORM/PART) is OFF.
- * Not received by the Rhythm Part (Part 10) when the Envelope Mode is NO-SUS.

● Note On

status	2nd byte	3rd byte
9nH	kkH	vvH

n=MIDI channel number: 0H - FH (ch.1 - ch.16)
kk=note number: 00H - 7FH (0 - 127)
vv=Note On velocity: 01H - 7FH (1 - 127)

- * Not received in Performance mode when the Receive Switch (PERFORM/PART) is OFF.

● Polyphonic Aftertouch

status	2nd byte	3rd byte
AnH	kkH	vvH

n=MIDI channel number: 0H - FH (ch.1 - ch.16)
kk=note number: 00H - 7FH (0 - 127)
vv=Aftertouch: 00H - 7FH (0 - 127)

- * This message is received if the Aftertouch Source (SYSTEM) is POLY or CH&POLY.
- * Not received in Performance mode when the Receive Switch (PERFORM/PART) is OFF.
- * Not received in GM mode.

● Control Change

- * If the corresponding Controller number is selected for the Patch Control Source 2/3 (PATCH), the corresponding effect will occur.
- * If a Controller number that corresponds to the System Control Source 1/2 (SYSTEM) is selected, the specified effect will apply if Patch Control Source 2/3 (PATCH) is set to SYS-CTRL1 or SYS-CTRL2.
- * Not received in Performance mode when the Receive Switch (PERFORM/PART) or the Control Change Receive Switch is OFF.

○Bank Select (Controller number 0,32)

status	2nd byte	3rd byte
BnH	00H	mmH
BnH	20H	llH

n=MIDI channel number: 0H - FH (ch.1 - ch.16)
mm,ll=Bank number: 00 00H - 7F 7FH (bank.1 - bank.16384)

- * Not received when the Receive Program Change or Receive Bank Select (SYSTEM) is OFF.
- * Not received in GM mode.

* The Patches corresponding to each Bank Select are as follows.

Bank Select	Program No	Group	Patch No.	
MSB LSB				
80	0	0 - 127	User	1 - 128
81	0	0 - 127	PR-A	1 - 128
81	1	0 - 127	PR-B	1 - 128
81	2	0 - 127	PR-C	1 - 128
81	3	0 - 127	GM	1 - 128
81	4	0 - 127	PR-E	1 - 128
84	0	0 - 127	XP-A (Session)	1 - 128
84	1	0 - 126	XP-A	129 - 255
84	2	0 - 127	XP-B	1 - 128
84	3	0 - 127	XP-B	129 - 256

* The Performance corresponding to each Bank Select are as follows.

Bank Select	Program No	Group	Performance No.	
MSB LSB				
80	0	0 - 31	User	1 - 32
81	0	0 - 31	PR-A	1 - 32
81	1	0 - 31	PR-B	1 - 32

* The Rhythm set corresponding to each Bank Select are as follows.

Bank Select	Program No	Group	Rhythm set No.	
MSB LSB				
80	0	0 - 1	User	1 - 2
81	0	0 - 1	PR-A	1 - 2
81	1	0 - 1	PR-B	1 - 2
81	2	0 - 1	PR-C	1 - 2
81	3	0 - 1	GM	1 - 2
81	4	0 - 1	PR-E	1 - 2
84	0	0 - 7	XP-A (Session)	1 - 8
84	2	0 - 127	XP-B	1 - 128
84	3	0 - 127	XP-B	129 - 256

○Modulation (Controller number 1)

status	2nd byte	3rd byte
BnH	01H	vvH

n=MIDI channel number: 0H - FH (ch.1 - ch.16)
vv=Modulation depth: 00H - 7FH (0 - 127)

○Breath type (Controller number 2)

status	2nd byte	3rd byte
BnH	02H	vvH

n=MIDI channel number: 0H - FH (ch.1 - ch.16)
vv=control value: 00H - 7FH (0 - 127)

○Foot type (Controller number 4)

status	2nd byte	3rd byte
BnH	04H	vvH

n=MIDI channel number: 0H - FH (ch.1 - ch.16)
vv=control value: 00H - 7FH (0 - 127)

○Portamento Time (Controller number 5)

status	2nd byte	3rd byte
BnH	05H	vvH

n=MIDI channel number: 0H - FH (ch.1 - ch.16)
vv=Portamento Time: 00H - 7FH (0 - 127)

- * Portamento Time will change.

○Data Entry (Controller number 6, 38)

status	2nd byte	3rd byte
BnH	06H	mmH
BnH	26H	llH

n=MIDI channel number: 0H - FH (ch.1 - ch.16)
mm,ll= the value of the parameter specified by RPN/NRPN
mm=MSB, ll=LSB

○Volume (Controller number 7)

status	2nd byte	3rd byte
BnH	07H	vvH

n=MIDI channel number: 0H - FH (ch.1 - ch.16)
vv=Volume: 00H - 7FH (0 - 127)

○Balance (Controller number 8)

status	2nd byte	3rd byte
BnH	08H	vvH

n=MIDI channel number: 0H - FH (ch.1 - ch.16)
vv=Balance: 00H - 7FH (0 - 127)

○Panpot (Controller number 10)

status	2nd byte	3rd byte
BnH	0AH	vvH
n=MIDI channel number:	0H - FH (ch.1 - ch.16)	
vv=Panpot:	00H - 40H - 7FH (left - center - right)	

* Adjust the stereo location over 128 steps, where 0 is far left, 64 is center, and 127 is far right. However this is not received when the Pan Control Switch is OFF.

○Expression (Controller number 11)

status	2nd byte	3rd byte
BnH	0BH	vvH
n=MIDI channel number:	0H - FH (ch.1 - ch.16)	
vv=Expression:	00H - 7FH (0 - 127)	

* If the Volume Control Source (SYSTEM) is set to VOL&EXP, the volume of the Part corresponding to the MIDI channel of the received message will be adjusted. However this is not received if the Receive Volume (PATCH) is OFF.
 * In GM mode, the volume can always be controlled.

○Hold 1 (Controller number 64)

status	2nd byte	3rd byte
BnH	40H	vvH
n=MIDI channel number:	0H - FH (ch.1 - ch.16)	
vv=control value:	00H - 7FH (0 - 127) 0-63=OFF, 64-127=ON	

* Not received when the Receive Hold-1 (PATCH) is OFF.

○Portamento (Controller number 65)

status	2nd byte	3rd byte
BnH	41H	vvH
n=MIDI channel number:	0H - FH (ch.1 - ch.16)	
vv=control value:	00H - 7FH (0 - 127) 0-63=OFF, 64-127=ON	

* The Portamento Sw (PATCH) will change.

○Sostenuto (Controller number 66)

status	2nd byte	3rd byte
BnH	42H	vvH
n=MIDI channel number:	0H - FH (ch.1 - ch.16)	
vv=control value:	00H - 7FH (0 - 127) 0-63=OFF, 64-127=ON	

○Soft (Controller number 67)

status	2nd byte	3rd byte
BnH	43H	vvH
n=MIDI channel number:	0H - FH (ch.1 - ch.16)	
vv=control value:	00H - 7FH (0 - 127) 0-63=OFF, 64-127=ON	

○Hold 2 (Controller number 69)

status	2nd byte	3rd byte
BnH	45H	vvH
n=MIDI channel number:	0H - FH (ch.1 - ch.16)	
vv=control value:	00H - 7FH (0 - 127)	

* A hold movement isn't done.

○Sound Controller 2 (Controller number 71)

status	2nd byte	3rd byte
BnH	47H	vvH
n=MIDI channel number:	0H - FH (ch.1 - ch.16)	
vv=control value:	00H - 40H - 7FH (-128 - 0 - +126)	

* The Resonance (PATCH) will change relatively.

○Sound Controller 3 (Controller number 72)

status	2nd byte	3rd byte
BnH	48H	vvH
n=MIDI channel number:	0H - FH (ch.1 - ch.16)	
vv=control value:	00H - 40H - 7FH (-128 - 0 - +126)	

* The Filter Envelope Time 2-4 (PATCH), Level Envelope Time 2-4 (PATCH) will change relatively.

○Sound Controller 4 (Controller number 73)

status	2nd byte	3rd byte
BnH	49H	vvH
n=MIDI channel number:	0H - FH (ch.1 - ch.16)	
vv=control value:	00H - 40H - 7FH (-128 - 0 - +126)	

* The Filter Envelope Time 1 (PATCH), The Level Envelope Time 1 (PATCH) will change relatively.

○Sound Controller 5 (Controller number 74)

status	2nd byte	3rd byte
BnH	4AH	vvH
n=MIDI channel number:	0H - FH (ch.1 - ch.16)	
vv=control value:	00H - 40H - 7FH (-64 - 0 - +63)	

* The Cutoff Frequency (PATCH) will change relatively.

○General Purpose Controller 5 (Controller number 80)

status	2nd byte	3rd byte
BnH	50H	vvH
n=MIDI channel number:	0H - FH (ch.1 - ch.16)	
vv=control value:	00H - 40H - 7FH (-128 - 0 - +126)	

* Level Envelope Level 1-3 (PATCH) of Tone 1 will change relatively.

○General Purpose Controller 6 (Controller number 81)

status	2nd byte	3rd byte
BnH	51H	vvH
n=MIDI channel number:	0H - FH (ch.1 - ch.16)	
vv=control value:	00H - 40H - 7FH (-128 - 0 - +126)	

* Level Envelope Level 1-3 (PATCH) of Tone 2 will change relatively.

○General Purpose Controller 7 (Controller number 82)

status	2nd byte	3rd byte
BnH	52H	vvH
n=MIDI channel number:	0H - FH (ch.1 - ch.16)	
vv=control value:	00H - 40H - 7FH (-128 - 0 - +126)	

* Level Envelope Level 1-3 (PATCH) of Tone 3 will change relatively.

○General Purpose Controller 8 (Controller number 83)

status	2nd byte	3rd byte
BnH	53H	vvH
n=MIDI channel number:	0H - FH (ch.1 - ch.16)	
vv=control value:	00H - 40H - 7FH (-128 - 0 - +126)	

* Level Envelope Level 1-3 (PATCH) of Tone 4 will change relatively.

○Portamento Control (Controller number 84)

status	2nd byte	3rd byte
BnH	54H	kkH
n=MIDI channel number:	0H - FH (ch.1 - ch.16)	
kk=source note number:	00H - 7FH (0 - 127)	

* A Note On message received immediately after a Portamento control will be sounded with the pitch changing smoothly from the source note number. If a voice is already sounding at the same note number as the source note number, that voice will change pitch to the pitch of the newly received Note On, and continue sounding (i.e., will be played legato).

* The speed of the pitch change caused by Portamento is determined by the Portamento Time value.

○Effect 1 (Reverb Send Level) (Controller number 91)

status	2nd byte	3rd byte
BnH	5BH	vvH
n=MIDI channel number:	0H - FH (ch.1 - ch.16)	
vv=Reverb Send Level:	00H - 7FH (0 - 127)	

* In Performance mode, the Reverb Send Level parameter of each Part will change.

MIDI Implementation

○ Effect 3 (Chorus Send Level) (Controller number 93)

status	2nd byte	3rd byte
BnH	5DH	vvH
n=MIDI channel number:	0H - FH (ch.1 - ch.16)	
vv=Chorus Send Level:	00H - 7FH (0 - 127)	

* In Performance mode, the Chorus Send Level parameter of each Part will change.

○ RPN MSB/LSB (Controller number 100,101)

status	2nd byte	3rd byte
BnH	65H	mmH
BnH	64H	llH
n=MIDI channel number:	0H - FH (ch.1 - ch.16)	
mm=MSB of the parameter number specified by RPN		
ll=LSB of the parameter number specified by RPN		

<<< RPN >>>

Control Changes include RPN (Registered Parameter Numbers), which are extended parameters whose function is defined in the MIDI specification.

When using RPNs, first the RPN (Controller numbers 100 and 101; they can be sent in any order) is transmitted to specify the parameter you wish to control. Then, Data Entry messages (Controller numbers 6 and 38) are used to set the value of the specified parameter. Once a RPN parameter has been specified, all further Data Entry messages on that channel are considered to apply to that specified parameter. In order to prevent accidents, when the desired setting has been made for the parameter, it is recommended that RPN be set to Null.

This device receives the following RPNs.

RPN	Data entry	Notes
MSB LSB	MSB LSB	
00H 00H	mmH -	Pitch Bend Sensitivity mm: 00H - 0CH (0 - 12 semitones) ll: ignored (processed as 00H) Up to 1 octave can be specified in semitone steps. * The Bend Range Up/Down will also be changed. * Not received by the Rhythm Part (Part 10).
00H 01H	mmH llH	Channel Fine Tuning mm, ll: 20 00H - 40 00H - 60 00H (-4096 x 100 / 8192 - 0 - +4096 x 100 / 8192 cent) * In Patch mode, the Master Tune (SYSTEM) will change. * In Performance mode, the Fine Tune (PERFORM) of each Part will change. When received on the Control channel, the Master Tune (SYSTEM) will change.
00H 02H	mmH -	Channel Coarse Tuning mm: 10H - 40H - 70H (-48 - 0 - +48 semitones) ll: ignored (processed as 00H) * Not received in Patch mode. * In Performance mode, the Coarse Tune (PERFORM/PART) of each Part will change.
7FH 7FH	--	RPN null RPN and NRPN will be set as "unspecified". Once this setting has been made, subsequent Data Entry messages will be ignored. (It is not necessary to transmit Data Entry for RPN Null settings. Parameter values that were previously set will not change. mm, ll: ignored

● Program Change

status	2nd byte
CnH	ppH
n=MIDI channel number:	0H - FH (ch.1 - ch.16)
pp=Program number:	00H - 7FH (prog.1 - prog.128)

- * Not received when the Receive Program Change is OFF.
- * When received on the Control channel, the Performance will change.
- * Not received in Performance mode when the Receive Switch (PERFORM/PART) is OFF.

● Channel Aftertouch

status	2nd byte
DnH	vvH
n=MIDI channel number:	0H - FH (ch.1 - ch.16)
vv=Channel Aftertouch:	00H - 7FH (0 - 127)

* Not received in Performance mode when the Receive Switch (PERFORM/PART) is OFF.

● Pitch Bend Change

status	2nd byte	3rd byte
EnH	llH	mmH
n=MIDI channel number:	0H - FH (ch.1 - ch.16)	
mm, ll=Pitch Bend value:	00 00H - 40 00H - 7F 7FH (-8192 - 0 - +8191)	

* Not received in Performance mode when the Receive Switch (PERFORM/PART) is OFF.

■ Channel Mode Messages

● All Sound Off (Controller number 120)

status	2nd byte	3rd byte
BnH	78H	00H
n=MIDI channel:	0H - FH (ch.1 - ch.16)	

- * When this message is received, all notes currently sounding on the corresponding channel will be turned off.
- * Not received in Performance mode when the Receive Switch (PERFORM/PART) is OFF.

● Reset All Controllers (Controller number 121)

status	2nd byte	3rd byte
BnH	79H	00H
n=MIDI channel number:	0H - FH (ch.1 - ch.16)	

- * Not received in Performance mode when the Receive Switch (PERFORM/PART) is OFF.
- * When this message is received, the following controllers will be set to their reset values.

Controller	Reset value
Pitch Bend Change	[+-]0 (center)
Polyphonic Key Pressure	0 (off)
Channel Pressure	0 (off)
Modulation	0 (off)
Breath type	0 (minimum)
Expression	127 (maximum) However the controller will be at minimum.
Hold 1	0 (off)
Sostenuto	0 (off)
Soft	0 (off)
Hold 2	0 (off)
RPN	Unset. Previously set data will not change.
NRPN	Unset. Previously set data will not change.
System General purpose controller 1	0 (minimum)
System General purpose controller 2	0 (minimum)

● All Note Off (Controller number 123)

status	2nd byte	3rd byte
BnH	7BH	00H
n=MIDI channel number:	0H - FH (ch.1 - ch.16)	

- * When All Note Off is received, all currently sounding notes of the corresponding channel will be turned off. However if Hold 1 or Sostenuto are on, the sound will be held until these are turned off.
- * Not received in Performance mode if the Receive Switch (PERFORM/PART) is OFF.

● Omni Off (Controller number 124)

status	2nd byte	3rd byte
BnH	7CH	00H
n=MIDI channel number:	0H - FH (ch.1 - ch.16)	

- * The same processing as when All Note Off is received will be done.
- * Not received in Performance mode if the Receive Switch (PERFORM/PART) is OFF.

● Omni On (Controller number 125)

<u>status</u>	<u>2nd byte</u>	<u>3rd byte</u>
BnH	7DH	00H
n=MIDI channel number:	0H - FH (ch.1 - ch.16)	

- * The same processing as when All Note Off is received will be done. The instrument will not be set to OMNI ON.
- * Not received in Performance mode if the Receive Switch (PERFORM/PART) is OFF.

● Mono (Controller number 126)

<u>status</u>	<u>2nd byte</u>	<u>3rd byte</u>
BnH	7EH	mmH
n=MIDI channel number:	0H - FH (ch.1 - ch.16)	
mm=Mono number:	00H - 10H (0 - 16)	

- * The same processing as when All Note Off is received will be done, and the Key Assign Mode (PATCH) will be set to SOLO.
- * Not received in Performance mode if the Receive Switch (PERFORM/PART) is OFF.

● Poly (Controller number 127)

<u>status</u>	<u>2nd byte</u>	<u>3rd byte</u>
BnH	7FH	00H
n=MIDI channel number:	0H - FH (ch.1 - ch.16)	

- * The same processing as when All Note Off is received will be done, and the Key Assign Mode (PATCH) will be set to POLY.
- * Not received in Performance mode if the Receive Switch (PERFORM/PART) is OFF.

■ System Realtime Messages

● Timing Clock

<u>status</u>
F8H

- * This message will be received if the Clock Source (SYSTEM) is MIDI.

● Active Sensing

<u>status</u>
FEH

- * When an Active Sensing message is received, the unit will begin monitoring the interval at which MIDI messages are received. During monitoring, if more than 420 ms passes without a message being received, the same processing will be done as when All Sound Off, All Note Off, and Reset All Controllers messages are received. Then monitoring will be halted.

■ System Exclusive Messages

<u>status</u>	<u>data byte</u>	<u>status</u>
F0H	iiH, ddH,, eeH	F7H

F0H: System Exclusive message status
 ii = ID number: This is the ID number (manufacturer ID) that specifies the manufacturer whose exclusive message this is. Roland's manufacturer ID is 41H. ID numbers 7EH and 7FH are defined in an expansion of the MIDI standard as Universal Non-realtime messages (7EH) and Universal Realtime Messages (7FH).
 dd, ..., ee = data: 00H - 7FH (0 - 127)
 F7H: EOX (End Of Exclusive)

Of the System Exclusive messages received by this device, the Universal Non-realtime messages and the Universal Realtime messages and the Data Request (RQ1) messages and the Data Set (DT1) messages will be set automatically.

- * The device ID number of this instrument is fixed at 10H (17).

● Universal Non-realtime System Exclusive Messages

○ Identity Request Message

When this message is received, Identity Reply message (p. 73) will be transmitted.

<u>status</u>	<u>data byte</u>	<u>status</u>
F0H	7EH, dev, 06H, 01H	F7H
<u>Byte</u>	<u>Remarks</u>	
F0H	Exclusive status	
7EH	ID number	(Universal Non-realtime message)
dev	device ID	(dev: 10H)
06H	sub ID#1	(General Information)
01H	sub ID#2	(Identity Request)
F7H	EOX	(End Of Exclusive)

- * The "dev" is own device number or 7FH (Broadcast).

○ GM System On

"GM System On" is a command message that resets the internal settings of the instrument to the GM initial state (General MIDI System - Level 1). A GM instrument that receives this message will automatically enter a state in which it can correctly perform a GM score.

<u>status</u>	<u>data byte</u>	<u>status</u>
F0H	7EH, 7FH, 09H, 01H	F7H
<u>Byte</u>	<u>Remarks</u>	
F0H	Exclusive status	
7EH	ID number	(Universal Non-realtime message)
7FH	device ID	(Broadcast)
09H	sub ID#1	(General MIDI Message)
01H	sub ID#2	(General MIDI On)
F7H	EOX	(End Of Exclusive)

○ GM System Off

When this messages is received, this instrument will return to the performance mode.

<u>status</u>	<u>data byte</u>	<u>status</u>
F0H	7EH, 7FH, 09H, 02H	F7H
<u>Byte</u>	<u>Remarks</u>	
F0H	Exclusive status	
7EH	ID number	(Universal Non-realtime message)
7FH	device ID	(Broadcast)
09H	sub ID#1	(General MIDI Message)
02H	sub ID#2	(General MIDI Off)
F7H	EOX	(End Of Exclusive)

● Universal Realtime System Exclusive Messages

○ Master Volume

<u>status</u>	<u>data byte</u>	<u>status</u>
F0H	7FH, 7FH, 04H, 01H, llH, mmH	F7H
<u>Byte</u>	<u>Remarks</u>	
F0H	Exclusive status	
7FH	ID number	(Universal Realtime message)
7FH	device ID	(Broadcast)
04H	sub ID#1	(Device Control Message)
01H	sub ID#2	(Master Volume)
llH	LSB of Master Volume	
mmH	MSB of Master Volume	
F7H	EOX	(End Of Exclusive)

- * LSB of Master Volume (llH) is processed as 00H.
- * This message is not received in GM mode.

MIDI Implementation

● Data Transmission

This instrument can use exclusive messages to exchange many varieties of internal settings with other devices.

The model ID of the exclusive messages used by this instrument is 6AH.

○Data Request 1 RQ1

This message requests the other device to transmit data. The address and size indicate the type and amount of data that is requested.

When a Data Request message is received, if the device is in a state in which it is able to transmit data, and if the address and size are appropriate, the requested data is transmitted as a Data Set 1 (DT1) message. If the conditions are not met, nothing is transmitted.

status	data byte	status
F0H	41H, dev, 6AH, 11H, aaH, bbH, ccH, ddH, ssH, ttH, uuH, vvH, sum	F7H

Byte	Remarks
F0H	Exclusive status
41H	ID number (Roland)
dev	device ID (dev: 10H)
6AH	model ID (JV-1010)
11H	command ID (RQ1)
aaH	address MSB
bbH	address
ccH	address
ddH	address LSB
ssH	size MSB
ttH	size
uuH	size
vvH	size LSB
sum	checksum
F7H	EOX (End Of Exclusive)

- * The size of data that can be transmitted at one time is fixed for each type of data, and data requests must be made with a fixed starting address and size. Refer to the address and size given in "Parameter Address Map" (p. 74).
- * For the checksum, refer to (p. 86).
- * This message is not received in GM mode.

○Data Set 1 DT1

This message transmits the actual data, and is used when you wish to set the data of the receiving device.

status	data byte	status
F0H	41H, dev, 6AH, 12H, aaH, bbH, ccH, ddH, eeH, ... ffH, sum	F7H

Byte	Remarks
F0H	Exclusive status
41H	ID number (Roland)
dev	device ID (dev: 10H)
6AH	model ID (JV-1010)
12H	command ID (DT1)
aaH	address MSB
bbH	address
ccH	address
ddH	address LSB
eeH	data: The actual data to be transmitted. Multi-byte data is transmitted in the order of the address.
:	:
ffH	data
sum	checksum
F7H	EOX (End Of Exclusive)

- * The amount of data that is transmitted at one time is fixed for the type of data, and only data of the fixed starting address and size will be transmitted. Refer to the address and size given in "Parameter Address Map" (p. 74).
- * Data whose size is greater than 128 bytes should be divided into packets of 128 bytes or less and transmitted. Successive "Data Set 1" messages should have at least 20 ms of time interval between them.
- * For the checksum, refer to (p. 86).
- * This message is not received in GM mode.

This device is able to receive GS Exclusive messages only for Scale Tune settings.

○Data Set 1 DT1

This message transmits the actual data, and is used when you wish to set the data of the receiving device.

status	data byte	status
F0H	41H, dev, 42H, 12H, aaH, bbH, ccH, ddH, ... eeH, sum	F7H

Byte	Remarks
F0H	Exclusive status
41H	ID number (Roland)
dev	device ID (dev: 10H)
42H	model ID (GS)
12H	command ID (DT1)
aaH	address MSB
bbH	address middle byte
ccH	address LSB
ddH	data: The actual data to be transmitted. Multi-byte data is transmitted in the address order.
:	:
eeH	data
sum	checksum
F7H	EOX (End Of Exclusive)

- * This message is not received in GM mode.

2. Data Transmission

■ Channel Voice Messages

- * The following control changes and program changes are transmitted to an external MIDI device when a GM Data Transfer command is executed.

● Control Change

○Data Entry (Controller number 6, 38)

status	2nd byte	3rd byte
BnH	06H	mmH
BnH	26H	llH

n=MIDI channel number: 0H - FH (ch.1 - ch.16)
mm,ll=the value of the parameter specified by RPN/NRPN
mm=MSB, ll=LSB

○Volume (Controller number 7)

status	2nd byte	3rd byte
BnH	07H	vvH

n=MIDI channel number: 0H - FH (ch.1 - ch.16)
vv=Volume: 00H - 7FH (0 - 127)

○Panpot (Controller number 10)

status	2nd byte	3rd byte
BnH	0AH	vvH

n=MIDI channel number: 0H - FH (ch.1 - ch.16)
vv=panpot: 00H - 40H - 7FH (left - center - right)

○Effect 1 (Reverb Send Level) (Controller number 91)

status	2nd byte	3rd byte
BnH	5BH	vvH

n=MIDI channel number: 0H - FH (ch.1 - ch.16)
vv=Reverb Send Level: 00H - 7FH (0 - 127)

○Effect 3 (Chorus Send Level) (Controller number 93)

status	2nd byte	3rd byte
BnH	5DH	vvH

n=MIDI channel: 0H - FH (ch.1 - ch.16)
vv=Chorus Send Level: 00H - 7FH (0 - 127)

○ RPN MSB/LSB (Controller number 100, 101)

<u>status</u>	<u>2nd byte</u>	<u>3rd byte</u>
BnH	65H	mmH
BnH	64H	llH

n=MIDI channel number: 0H - FH (ch.1 - ch.16)
 mm=MSB of the parameter number specified by RPN
 ll=LSB of the parameter number specified by RPN

<<< RPN >>>

Control Changes include RPN (Registered Parameter Numbers), which are extended parameters whose function is defined in the MIDI specification. When using RPNs, first the RPN (Controller numbers 100 and 101; they can be sent in any order) is transmitted to specify the parameter you wish to control. Then, Data Entry messages (Controller numbers 6 and 38) are used to set the value of the specified parameter. Once a RPN parameter has been specified, all further Data Entry messages on that channel are considered to apply to that specified parameter. In order to prevent accidents, when the desired setting has been made for the parameter, it is recommended that RPN be set to Null.

This device transmits the following RPNs.

RPN	Data entry	Notes
MSB LSB	MSB LSB	
00H 00H	mmH -	Pitch Bend Sensitivity mm: 00H - 0CH (0 - 12 semitones) ll: ignored (processed as 00H) Up to 1 octave can be specified in semitone steps. * The Bend Range Up/Down will also be changed. * Not received by the Rhythm Part (Part 10).
00H 01H	mmH llH	Channel Fine Tuning mm, ll: 20 00H - 40 00H - 60 00H (-4096 x 100 / 8192 - 0 - +4096 x 100 / 8192 cent) * In Patch mode, the Master Tune (SYSTEM) will change. * In Performance mode, the Fine Tune (PERFORM) of each Part will change. When received on the Control channel, the Master Tune (SYSTEM) will change.
00H 02H	mmH -	Channel Coarse Tuning mm: 10H - 40H - 70H (-48 - 0 - +48 semitones) ll: ignored (processed as 00H) * Not received in Patch mode. * In Performance mode, the Coarse Tune (PERFORM/PART) of each Part will change.

● Program Change

<u>status</u>	<u>2nd byte</u>
CnH	ppH

n=MIDI channel: 0H - FH (ch.1 - ch.16)
 pp=Program number: 00H - 7FH (prog.1 - prog.128)

■ System Exclusive Messages

There is a kind of the Universal Non-realtime messages and the Data Set (DT1) messages in the System Exclusive messages transmitted by this device.

* The device ID number of this instrument is fixed at 10H (17).

● Universal Non-realtime System Exclusive Messages

○ Identity Reply Message

When Identity Request message (p. 71) is received, this message will be transmitted.

<u>status</u>	<u>data byte</u>	<u>status</u>
F0H	7EH, dev, 06H, 02H, 41H, 6AH, 00H, 05H, 00H, 00H, 00H, 00H, 00H	F7H

Byte	Remarks
F0H	Exclusive status
7EH	ID number (Universal Non-realtime message)
dev	device ID (dev: 10H)
06H	sub ID#1 (General Information)
02H	sub ID#2 (Identity Reply)
41H	ID number (Roland)
6AH 00H	Device family code
05H 00H	Device family number code
00H 00H 00H 00H	Software revision level
F7H	EOX (End Of Exclusive)

● Data Transmission

○ Data Set1 DT1

<u>status</u>	<u>data byte</u>	<u>status</u>
F0H	41H, dev, 6AH, 12H, aaH, bbH, ccH, ddH, eeH, ... ffH, sum	F7H

Byte	Remarks
F0H	Exclusive status
41H	ID number (Roland)
dev	device ID (dev: 10H)
6AH	model ID (JV-1010)
12H	command ID (DT1)
aaH	address MSB
bbH	address
ccH	address
ddH	address LSB
eeH	data: The actual data to be transmitted. Multi-byte data is transmitted in the address order.
:	:
ffH	data
sum	checksum
F7H	EOX (End Of Exclusive)

* The amount of data transmitted at one time is fixed for the type of data, and the data will be transmitted with the fixed starting address and size. Refer to the address and size given in "Parameter Address Map" (p. 74).

* Large amounts of data must be divided into packets of 128 bytes or less, and transmitted at intervals of approximately 20 ms.

* For the checksum, refer to (p. 86).

MIDI Implementation

3. Parameter Address Map

1. JV-1010 (Model ID=6AH)

* For addresses marked by a #, the data must be divided into 2 parts for transmission. For example, data with the hexadecimal value ABH would be divided into 0AH and 0BH, and transmitted in that order.

* Parameter values enclosed in <> are for the JV-1080 / JV-2080 / XP-30 / XP-50 / XP-60 / XP-80, and will be ignored if received by the JV-1010.

Start Address	Description	
00 00 00 00	System	1-1
01 00 00 00	Temporary Performance	1-2
02 00 00 00	Performance Mode Temporary Patch(part 1)	1-3
02 01 00 00	Performance Mode Temporary Patch(part 2)	
:		
02 08 00 00	Performance Mode Temporary Patch(part 9)	
02 09 00 00	Temporary Rhythm Setup	1-4
02 0A 00 00	Performance Mode Temporary Patch(part 11)	1-3
:		
02 0F 00 00	Performance Mode Temporary Patch(part 16)	
03 00 00 00	Patch Mode Temporary Patch	1-3
10 00 00 00	User Performance USER:01	1-2
10 01 00 00	User Performance USER:02	
:		
10 1F 00 00	User Performance USER:32	
10 40 00 00	User Rhythm Setup USER:1	1-4
10 41 00 00	User Rhythm Setup USER:2	
11 00 00 00	User Patch USER:001	1-3
11 01 00 00	User Patch USER:002	
:		
11 7F 00 00	User Patch USER:128	

● 1-1.System

Offset Address	Description	
00 00	System Common	1-1-1
10 00	Part 1 Scale Tune	1-1-2
11 00	Part 2 Scale Tune	
:		
1F 00	Part 16 Scale Tune	
20 00	Patch Mode Scale Tune	1-1-2

● 1-1-1.System Common

Offset Address	Size	Description	Data (Value)
00 00	0000 00aa	Sound Mode	0 - 2 *1
00 01	0aaa aaaa	Performance Number	0 - 127 *2
00 02	0000 00aa	Patch Group Type	0 - 2 *3 -->
00 03	0aaa aaaa	Patch Group ID	0 - 127 -->
# 00 04	0000 aaaa	Patch Number	0 - 255 -->
	0000 bbbb		(001 - 256)
00 06	0aaa aaaa	Master Tune	0 - 126 *4
00 07	0000 000a	Scale Tune Switch	0 - 1 (OFF,ON)
00 08	0000 000a	EFX Switch	0 - 1 (OFF,ON)
00 09	0000 000a	Chorus Switch	0 - 1 (OFF,ON)
00 0A	0000 000a	Reverb Switch	0 - 1 (OFF,ON)
00 0B	0000 000a	Patch Remain	0 - 1 (OFF,ON)
00 0C	0000 000a	Clock Source	0 - 1 (INT,MIDI)
00 0D	0000 0aaa	TAP Control Source	0 - 4 *5
00 0E	0000 0aaa	Hold Control Source	0 - 4 *5
00 0F	0000 0aaa	Peak Control Source	0 - 4 *5
00 10	0000 000a	Volume Control Source	0 - 1 *6
00 11	0000 00aa	Aftertouch Source	0 - 2 *7
00 12	0aaa aaaa	System Control Source 1	1 - 97 *8
00 13	0aaa aaaa	System Control Source 2	1 - 97 *8
00 14	0000 000a	Receive Program Change	0 - 1 (OFF,ON)
00 15	0000 000a	Receive Bank Select	0 - 1 (OFF,ON)
00 16	0000 000a	Receive Control Change	0 - 1 (<OFF,ON>)
00 17	0000 000a	Receive Modulation	0 - 1 (<OFF,ON>)
00 18	0000 000a	Receive Volume	0 - 1 (<OFF,ON>)
00 19	0000 000a	Receive Hold-1	0 - 1 (<OFF,ON>)
00 1A	0000 000a	Receive Pitch Bend	0 - 1 (<OFF,ON>)
00 1B	0000 000a	Receive Aftertouch	0 - 1 (<OFF,ON>)
00 1C	000a aaaa	Control Channel	0 - 16 (1 - 16,OFF)
00 1D	0000 aaaa	Patch Receive Channel	0 - 15 (1 - 16)
00 1E	0000 000a	Rhythm Edit Source	0 - 1 *9
00 1F	0000 00aa	Preview Sound Mode	0 - 2 *10
00 20	0aaa aaaa	Preview Note Set 1	0 - 127 (C-1 - G9)
00 21	0aaa aaaa	Preview Velocity Set 1	0 - 127 *11
00 22	0aaa aaaa	Preview Note Set 2	0 - 127 (C-1 - G9)
00 23	0aaa aaaa	Preview Velocity Set 2	0 - 127 *11
00 24	0aaa aaaa	Preview Note Set 3	0 - 127 (C-1 - G9)
00 25	0aaa aaaa	Preview Velocity Set 3	0 - 127 *11
00 26	0aaa aaaa	Preview Note Set 4	0 - 127 (C-1 - G9)
00 27	0aaa aaaa	Preview Velocity Set 4	0 - 127 *11
00 28	0000 000a	Transmit Program Change	0 - 1 (<OFF,ON>)
00 29	0000 000a	Transmit Bank Select	0 - 1 (<OFF,ON>)
00 2A	000a aaaa	Patch Transmit Channel	0 - 17 *12
00 2B	0000 000a	Transpose Switch	0 - 1 (<OFF,ON>)
00 2C	0000 aaaa	Transpose Value	0 - 11 (<-5 - +6>)
00 2D	0000 0aaa	Octave Shift	0 - 6 (<-3 - +3>)
00 2E	0aaa aaaa	Keyboard Velocity	0 - 127 *13
00 2F	0000 00aa	Keyboard Sens	0 - 2 *14
00 30	0aaa aaaa	Aftertouch Sens	0 - 100 (<0 - 100>)
00 31	0aaa aaaa	Pedal(1) Assign	1 - 104 *15
00 32	0000 00aa	Pedal(1) Output Mode	0 - 3 *16

Patch Group	Group Type	Group ID	Number (value)
USER	0	1	0 - 127 (001 - 128)
<CARD	0	2	0 - 127 (001 - 128)>
PR-A	0	3	0 - 127 (001 - 128)
PR-B	0	4	0 - 127 (001 - 128)
PR-C	0	5	0 - 127 (001 - 128)
PR-D	0	6	0 - 127 (001 - 128)
PR-E	0	7	0 - 127 (001 - 128)
<PCM	1	1 - 127	0 - 127 (001 - 128)>
XP-A(Session)	2	9	0 - 254 (001 - 255)
XP-B	2	1 - 127	0 - 255 (001 - 256)

00 33	0000 000a	Pedal(1) Polarity	0 - 1	*17
00 34	0aaa aaaa	Pedal2 Assign	1 - 104	*15
00 35	0000 00aa	Pedal2 Output Mode	0 - 3	*16
00 36	0000 000a	Pedal2 Polarity	0 - 1	*17
00 37	0aaa aaaa	C1 Assign	1 - 97	*18
00 38	0000 00aa	C1 Output Mode	0 - 3	*16
00 39	0aaa aaaa	C2 Assign	1 - 97	*18
00 3A	0000 00aa	C2 Output Mode	0 - 3	*16
00 3B	0000 00aa	Hold Pedal Output Mode	0 - 3	*16
00 3C	0000 000a	Hold Pedal Polarity	0 - 1	*17
<hr/>				
00 3D	0000 000a	Bank Select Group1 Switch	0 - 1	(<OFF,ON>)
00 3E	0aaa aaaa	Bank Select Group1 MSB	0 - 127	(<0 - 127>)
00 3F	0aaa aaaa	Bank Select Group1 LSB	0 - 127	(<0 - 127>)
00 40	0000 000a	Bank Select Group2 Switch	0 - 1	(<OFF,ON>)
00 41	0aaa aaaa	Bank Select Group2 MSB	0 - 127	(<0 - 127>)
00 42	0aaa aaaa	Bank Select Group2 LSB	0 - 127	(<0 - 127>)
00 43	0000 000a	Bank Select Group3 Switch	0 - 1	(<OFF,ON>)
00 44	0aaa aaaa	Bank Select Group3 MSB	0 - 127	(<0 - 127>)
00 45	0aaa aaaa	Bank Select Group3 LSB	0 - 127	(<0 - 127>)
00 46	0000 000a	Bank Select Group4 Switch	0 - 1	(<OFF,ON>)
00 47	0aaa aaaa	Bank Select Group4 MSB	0 - 127	(<0 - 127>)
00 48	0aaa aaaa	Bank Select Group4 LSB	0 - 127	(<0 - 127>)
00 49	0000 000a	Bank Select Group5 Switch	0 - 1	(<OFF,ON>)
00 4A	0aaa aaaa	Bank Select Group5 MSB	0 - 127	(<0 - 127>)
00 4B	0aaa aaaa	Bank Select Group5 LSB	0 - 127	(<0 - 127>)
00 4C	0000 000a	Bank Select Group6 Switch	0 - 1	(<OFF,ON>)
00 4D	0aaa aaaa	Bank Select Group6 MSB	0 - 127	(<0 - 127>)
00 4E	0aaa aaaa	Bank Select Group6 LSB	0 - 127	(<0 - 127>)
00 4F	0000 000a	Bank Select Group7 Switch	0 - 1	(<OFF,ON>)
00 50	0aaa aaaa	Bank Select Group7 MSB	0 - 127	(<0 - 127>)
00 51	0aaa aaaa	Bank Select Group7 LSB	0 - 127	(<0 - 127>)
<hr/>				
00 52	0aaa aaaa	Pedal3 Assign	1 - 104	*15
00 53	0000 00aa	Pedal3 Output Mode	0 - 3	*16
00 54	0000 000a	Pedal3 Polarity	0 - 1	*17
00 55	0aaa aaaa	Pedal4 Assign	1 - 104	*15
00 56	0000 00aa	Pedal4 Output Mode	0 - 3	*16
00 57	0000 000a	Pedal4 Polarity	0 - 1	*17
<hr/>				
00 58	00aa aaaa	Arpeggio Style	0 - 42	(<1 - 43>)
00 59	00aa aaaa	Arpeggio Motif	0 - 37	(<1 - 38>)
00 5A	0aaa aaaa	Arpeggio Beat Pattern	0 - 114	(<1 - 115>)
00 5B	0aaa aaaa	Arpeggio Accent Rate	0 - 100	(<0 - 100>)
00 5C	0aaa aaaa	Arpeggio Shuffle Rate	50 - 90	(<50 - 90>)
00 5D	0aaa aaaa	Arpeggio Keyboard Velocity	0 - 127	*13
00 5E	0000 0aaa	Arpeggio Octave Range	0 - 6	(<-3 - +3>)
00 5F	0000 aaaa	Arpeggio Part Number	0 - 15	*19
<hr/>				
#	00 60	0000 aaaa 0000 bbbb	System Tempo	20 - 250
<hr/>				
00 62	0aaa aaaa	C3 Assign	1 - 97	*18
00 63	0000 00aa	C3 Output Mode	0 - 3	*16
00 64	0aaa aaaa	C4 Assign	1 - 97	*18
00 65	0000 00aa	C4 Output Mode	0 - 3	*16
<hr/>				
Total size	00 00 00 66			

- *1 PERFORMANCE, PATCH, GM
- *2 USER:01-USER:32, <CARD:01-CARD:32>, PR-A:01-PR-A:32, PR-B:01-PR-B:32
- *3 USER&PRESET, <PCM>, EXP
- *4 427.4-452.6
- *5 OFF, HOLD-1, SOSTENUTO, SOFT, HOLD-2
- *6 VOLUME, VOLUME&EXPRESSION
- *7 CHANNEL, POLY, CH&POLY
- *8 CC01-CC05, CC07-CC31, CC64-CC95, PITCH BEND, AFTERTOUC
- *9 <PANEL, PANEL&MIDI>
- *10 SINGLE, CHORD, PHRASE
- *11 OFF, 1-127
- *12 <1-16, RX-CH, OFF>
- *13 <REAL, 1-127>
- *14 <LIGHT, MEDIUM, HEAVY>
- *15 <CC01-CC05, CC07-CC31, CC64-CC95, PITCH BEND, AFTERTOUC, PROG-UP, PROG-DOWN, START/STOP, PUNCH-IN/OUT, TAP-TEMPO, OCTAVE-UP, OCTAVE-DOWN>
- *16 <OFF, INT, MIDI, INT&MIDI>
- *17 <STANDARD, REVERSE>
- *18 <CC01-CC05, CC07-CC31, CC64-CC95, PITCH BEND, AFTERTOUC>
- *19 <PART1-PART16>

● 1-1-2.Scale Tune

Offset	Address	Size	Description	Data (Value)
	00 00	0aaa aaaa	Scale Tune for C	0 - 127 (-64 - +63)
	00 01	0aaa aaaa	Scale Tune for C#	0 - 127 (-64 - +63)
	00 02	0aaa aaaa	Scale Tune for D	0 - 127 (-64 - +63)
	00 03	0aaa aaaa	Scale Tune for D#	0 - 127 (-64 - +63)
	00 04	0aaa aaaa	Scale Tune for E	0 - 127 (-64 - +63)
	00 05	0aaa aaaa	Scale Tune for F	0 - 127 (-64 - +63)
	00 06	0aaa aaaa	Scale Tune for F#	0 - 127 (-64 - +63)
	00 07	0aaa aaaa	Scale Tune for G	0 - 127 (-64 - +63)
	00 08	0aaa aaaa	Scale Tune for G#	0 - 127 (-64 - +63)
	00 09	0aaa aaaa	Scale Tune for A	0 - 127 (-64 - +63)
	00 0A	0aaa aaaa	Scale Tune for A#	0 - 127 (-64 - +63)
	00 0B	0aaa aaaa	Scale Tune for B	0 - 127 (-64 - +63)
<hr/>				
Total size	00 00 00 0C			

MIDI Implementation

● 1-2.Performance

Offset Address	Description	
00 00	Performance Common	1-2-1
10 00	Performance Part 1	1-2-2
11 00	Performance Part 2	
:		
1F 00	Performance Part 16	

● 1-2-1.Performance Common

Offset Address	Size	Description	Data (Value)
00 00	0aaa aaaa	Performance Name 1	32 - 127
00 01	0aaa aaaa	Performance Name 2	32 - 127
00 02	0aaa aaaa	Performance Name 3	32 - 127
00 03	0aaa aaaa	Performance Name 4	32 - 127
00 04	0aaa aaaa	Performance Name 5	32 - 127
00 05	0aaa aaaa	Performance Name 6	32 - 127
00 06	0aaa aaaa	Performance Name 7	32 - 127
00 07	0aaa aaaa	Performance Name 8	32 - 127
00 08	0aaa aaaa	Performance Name 9	32 - 127
00 09	0aaa aaaa	Performance Name 10	32 - 127
00 0A	0aaa aaaa	Performance Name 11	32 - 127
00 0B	0aaa aaaa	Performance Name 12	32 - 127
00 0C	0000 aaaa	EFX Source	0 - 15 *1
00 0D	00aa aaaa	EFX Type	0 - 39 (1 - 40)
00 0E	0aaa aaaa	EFX Parameter 1	0 - 127
00 0F	0aaa aaaa	EFX Parameter 2	0 - 127
00 10	0aaa aaaa	EFX Parameter 3	0 - 127
00 11	0aaa aaaa	EFX Parameter 4	0 - 127
00 12	0aaa aaaa	EFX Parameter 5	0 - 127
00 13	0aaa aaaa	EFX Parameter 6	0 - 127
00 14	0aaa aaaa	EFX Parameter 7	0 - 127
00 15	0aaa aaaa	EFX Parameter 8	0 - 127
00 16	0aaa aaaa	EFX Parameter 9	0 - 127
00 17	0aaa aaaa	EFX Parameter 10	0 - 127
00 18	0aaa aaaa	EFX Parameter 11	0 - 127
00 19	0aaa aaaa	EFX Parameter 12	0 - 127
00 1A	0000 00aa	EFX Output Assign	0 - 2 *2
00 1B	0aaa aaaa	EFX Mix Out Send Level	0 - 127
00 1C	0aaa aaaa	EFX Chorus Send Level	0 - 127
00 1D	0aaa aaaa	EFX Reverb Send Level	0 - 127
00 1E	0000 aaaa	EFX Control Source 1	0 - 10 *3
00 1F	0aaa aaaa	EFX Control Depth 1	0 - 126 (-63 - +63)
00 20	0000 aaaa	EFX Control Source 2	0 - 10 *3
00 21	0aaa aaaa	EFX Control Depth 2	0 - 126 (-63 - +63)
00 22	0aaa aaaa	Chorus Level	0 - 127
00 23	0aaa aaaa	Chorus Rate	0 - 127
00 24	0aaa aaaa	Chorus Depth	0 - 127
00 25	0aaa aaaa	Chorus Pre-Delay	0 - 127
00 26	0aaa aaaa	Chorus Feedback	0 - 127
00 27	0000 00aa	Chorus Output	0 - 2 *4
00 28	0000 0aaa	Reverb Type	0 - 7 *5
00 29	0aaa aaaa	Reverb Level	0 - 127
00 2A	0aaa aaaa	Reverb Time	0 - 127
00 2B	000a aaaa	Reverb HF Damp	0 - 17 *6
00 2C	0aaa aaaa	Delay Feedback	0 - 127
# 00 2D	0000 aaaa	Performance Tempo	20 - 250
00 2E	0000 bbbb		
00 2F	0000 000a	Keyboard Range Switch	0 - 1 (OFF,ON)
00 30	0aaa aaaa	Voice Reserve 1	0 - 64
00 31	0aaa aaaa	Voice Reserve 2	0 - 64
00 32	0aaa aaaa	Voice Reserve 3	0 - 64
00 33	0aaa aaaa	Voice Reserve 4	0 - 64
00 34	0aaa aaaa	Voice Reserve 5	0 - 64
00 35	0aaa aaaa	Voice Reserve 6	0 - 64
00 36	0aaa aaaa	Voice Reserve 7	0 - 64
00 37	0aaa aaaa	Voice Reserve 8	0 - 64
00 38	0aaa aaaa	Voice Reserve 9	0 - 64
00 39	0aaa aaaa	Voice Reserve 10	0 - 64
00 3A	0aaa aaaa	Voice Reserve 11	0 - 64
00 3B	0aaa aaaa	Voice Reserve 12	0 - 64
00 3C	0aaa aaaa	Voice Reserve 13	0 - 64
00 3D	0aaa aaaa	Voice Reserve 14	0 - 64
00 3E	0aaa aaaa	Voice Reserve 15	0 - 64
00 3F	0aaa aaaa	Voice Reserve 16	0 - 64
00 40	0000 000a	Keyboard Mode	0 - 1 *7
00 41	0000 000a	Clock Source	0 - 1 *8
Total size	00 00 00 42		

*1 PERFORM, 1-9, 11-16

*2 MIX, <DIRECT-1>, <DIRECT-2>

*3 OFF, SYS-CTRL1, SYS-CTRL2, MODULATION, BREATH, FOOT, VOLUME, PAN, EXPRESSION, PITCH BEND, AFTERTOUCH

*4 MIX, REV, MIX+REV

*5 ROOM1, ROOM2, STAGE1, STAGE2, HALL1, HALL2, DELAY, PAN-DLY

*6 200, 250, 315, 400, 500, 630, 800, 1000, 1250, 1600, 2000, 2500, 3150, 4000, 5000, 6300, 8000, BYPASS

*7 <LAYER, SINGLE>

*8 PERFORMANCE, SYSTEM

● 1-2-2. Performance Part

Offset Address	Size	Description	Data (Value)
00 00	0000 000a	Receive Switch	0 - 1 (OFF,ON)
00 01	0000 aaaa	MIDI Channel	0 - 15 (1 - 16)
# 00 02	0000 00aa	Patch Group Type	0 - 2 *1 ->
00 03	0aaa aaaa	Patch Group ID	0 - 127 ->
00 04	0000 aaaa	Patch Number	0 - 255 ->
	0000 bbbb		(001 - 256)
00 06	0aaa aaaa	Part Level	0 - 127
00 07	0aaa aaaa	Part Pan	0 - 127 (L64 - 63R)
00 08	0aaa aaaa	Part Coarse Tune	0 - 96 (-48 - +48)
00 09	0aaa aaaa	Part Fine Tune	0 - 100 (-50 - +50)
00 0A	0000 0aaa	Output Assign	0 - 4 *2
00 0B	0aaa aaaa	Mix/EFX Send Level	0 - 127
00 0C	0aaa aaaa	Chorus Send Level	0 - 127
00 0D	0aaa aaaa	Reverb Send Level	0 - 127
00 0E	0000 00aa	Receive Program Change Switch	0 - 1 (OFF,ON)
00 0F	0000 000a	Receive Volume Switch	0 - 1 (OFF,ON)
00 10	0000 000a	Receive Hold-1 Switch	0 - 1 (OFF,ON)
00 11	0aaa aaaa	Keyboard Range Lower	0 - 127 *3
00 12	0aaa aaaa	Keyboard Range Upper	0 - 127 *4
00 13	0000 0aaa	Octave Shift	0 - 6 (<-3 - +3>)
00 14	0000 000a	Local Switch	0 - 1 (<OFF,ON>)
00 15	0000 000a	Transmit Switch	0 - 1 (<OFF,ON>)
00 16	0000 0aaa	Transmit Bank Select Group	0 - 7 *5
# 00 17	0000 aaaa	Transmit Volume	0 - 128
	0000 bbbb		(<0 - 127,OFF>)
Total size	00 00 00 19		

Patch Group	Group Type	Group ID	Number (value)
USER	0	1	0 - 127 (001 - 128)
<CARD	0	2	0 - 127 (001 - 128)>
PR-A	0	3	0 - 127 (001 - 128)
PR-B	0	4	0 - 127 (001 - 128)
PR-C	0	5	0 - 127 (001 - 128)
PR-D	0	6	0 - 127 (001 - 128)
PR-E	0	7	0 - 127 (001 - 128)
<PCM	1	1 - 127	0 - 127 (001 - 128)>
XP-A(Session)	2	9	0 - 254 (001 - 255)
XP-B	2	1 - 127	0 - 255 (001 - 256)

*1 USER&PRESET, <PCM>, EXP

*2 MIX, EFX, <DIRECT-1>, <DIRECT-2>, PATCH

*3 C-1-Upper

*4 Lower-G9

*5 <PATCH, GROUP1-GROUP7>

● 1-3. Patch

Offset Address	Description
00 00	Patch Common 1-3-1
10 00	Patch Tone 1 1-3-2
12 00	Patch Tone 2
14 00	Patch Tone 3
16 00	Patch Tone 4

● 1-3-1. Patch Common

Offset Address	Size	Description	Data (Value)
00 00	0aaa aaaa	Patch Name 1	32 - 127
00 01	0aaa aaaa	Patch Name 2	32 - 127
00 02	0aaa aaaa	Patch Name 3	32 - 127
00 03	0aaa aaaa	Patch Name 4	32 - 127
00 04	0aaa aaaa	Patch Name 5	32 - 127
00 05	0aaa aaaa	Patch Name 6	32 - 127
00 06	0aaa aaaa	Patch Name 7	32 - 127
00 07	0aaa aaaa	Patch Name 8	32 - 127
00 08	0aaa aaaa	Patch Name 9	32 - 127
00 09	0aaa aaaa	Patch Name 10	32 - 127
00 0A	0aaa aaaa	Patch Name 11	32 - 127
00 0B	0aaa aaaa	Patch Name 12	32 - 127
00 0C	00aa aaaa	EFX Type	0 - 39 (1 - 40)
00 0D	0aaa aaaa	EFX Parameter 1	0 - 127
00 0E	0aaa aaaa	EFX Parameter 2	0 - 127
00 0F	0aaa aaaa	EFX Parameter 3	0 - 127
00 10	0aaa aaaa	EFX Parameter 4	0 - 127
00 11	0aaa aaaa	EFX Parameter 5	0 - 127
00 12	0aaa aaaa	EFX Parameter 6	0 - 127
00 13	0aaa aaaa	EFX Parameter 7	0 - 127
00 14	0aaa aaaa	EFX Parameter 8	0 - 127
00 15	0aaa aaaa	EFX Parameter 9	0 - 127
00 16	0aaa aaaa	EFX Parameter 10	0 - 127
00 17	0aaa aaaa	EFX Parameter 11	0 - 127
00 18	0aaa aaaa	EFX Parameter 12	0 - 127
00 19	0000 00aa	EFX Output Assign	0 - 2 *1
00 1A	0aaa aaaa	EFX Mix Out Send Level	0 - 127
00 1B	0aaa aaaa	EFX Chorus Send Level	0 - 127
00 1C	0aaa aaaa	EFX Reverb Send Level	0 - 127
00 1D	0000 aaaa	EFX Control Source 1	0 - 10 *2
00 1E	0aaa aaaa	EFX Control Depth 1	0 - 126 (-63 - +63)
00 1F	0000 aaaa	EFX Control Source 2	0 - 10
00 20	0aaa aaaa	EFX Control Depth 2	0 - 126 (-63 - +63)
00 21	0aaa aaaa	Chorus Level	0 - 127
00 22	0aaa aaaa	Chorus Rate	0 - 127
00 23	0aaa aaaa	Chorus Depth	0 - 127
00 24	0aaa aaaa	Chorus Pre-Delay	0 - 127
00 25	0aaa aaaa	Chorus Feedback	0 - 127
00 26	0000 00aa	Chorus Output	0 - 2 *3
00 27	0000 0aaa	Reverb Type	0 - 7 *4
00 28	0aaa aaaa	Reverb Level	0 - 127
00 29	0aaa aaaa	Reverb Time	0 - 127
00 2A	000a aaaa	Reverb HF Damp	0 - 17 *5
00 2B	0aaa aaaa	Delay Feedback	0 - 127

MIDI Implementation

#	00 2C	0000 aaaa	Patch Tempo	20 - 250
		0000 bbbb		
	00 2E	0aaa aaaa	Patch Level	0 - 127
	00 2F	0aaa aaaa	Patch Pan	0 - 127 (L64 - 63R)
	00 30	0aaa aaaa	Analog Feel	0 - 127
	00 31	0000 aaaa	Bend Range Up	0 - 12
	00 32	00aa aaaa	Bend Range Down	0 - 48 (0 - -48)
	00 33	0000 000a	Key Assign Mode	0 - 1 (POLY, SOLO)
	00 34	0000 000a	Solo Legato	0 - 1 (OFF, ON)
	00 35	0000 000a	Portamento Switch	0 - 1 (OFF, ON)
	00 36	0000 000a	Portamento Mode	0 - 1 *6
	00 37	0000 000a	Portamento Type	0 - 1 (RATE, TIME)
	00 38	0000 000a	Portamento Start	0 - 1 *7
	00 39	0aaa aaaa	Portamento Time	0 - 127
	00 3A	0000 aaaa	Patch Control Source 2	0 - 15 *8
	00 3B	0000 aaaa	Patch Control Source 3	0 - 15 *8
	00 3C	0000 00aa	AFX Control Hold/Peak	0 - 2 *9
	00 3D	0000 00aa	Control 1 Hold/Peak	0 - 2 *9
	00 3E	0000 00aa	Control 2 Hold/Peak	0 - 2 *9
	00 3F	0000 00aa	Control 3 Hold/Peak	0 - 2 *9
	00 40	0000 000a	Velocity Range Switch	0 - 1 (OFF, ON)
	00 41	0000 0aaa	Octave Shift	0 - 6 (-3 - +3)
	00 42	0000 00aa	Stretch Tune Depth	0 - 3 (OFF, 1 - 3)
	00 43	0000 000a	Voice Priority	0 - 1 *10
	00 44	0000 aaaa	Structure Type 1&2	0 - 9 (1 - 10)
	00 45	0000 00aa	Booster 1&2	0 - 3 *11
	00 46	0000 aaaa	Structure Type 3&4	0 - 9 (1 - 10)
	00 47	0000 00aa	Booster 3&4	0 - 3 *11
	00 48	0000 000a	Clock Source	0 - 1 *12
	00 49	0aaa aaaa	Patch Category	0 - 127 *13
Total size	00 00 00 4A			

- *1 MIX, <DIRECT-1>, <DIRECT-2>
- *2 OFF, SYS-CTRL1, SYS-CTRL2, MODULATION, BREATH, FOOT, VOLUME, PAN, EXPRESSION, PITCH BEND, AFTERTOUCH
- *3 MIX, REV, MIX+REV
- *4 ROOM1, ROOM2, STAGE1, STAGE2, HALL1, HALL2, DELAY, PAN-DLY
- *5 200, 250, 315, 400, 500, 630, 800, 1000, 1250, 1600, 2000, 2500, 3150, 4000, 5000, 6300, 8000, BYPASS
- *6 NORMAL, LEGATO
- *7 PITCH, NOTE
- *8 OFF, SYS-CTRL1, SYS-CTRL2, MODULATION, BREATH, FOOT, VOLUME, PAN, EXPRESSION, PITCH BEND, AFTERTOUCH, LFO1, LFO2, VELOCITY, KEYFOLLOW, PLAYMATE
- *9 OFF, HOLD, PEAK
- *10 LAST, LOUDEST
- *11 0, +6, +12, +18
- *12 PATCH, SYSTEM
- *13 NO ASSIGN, AC.PIANO, EL.PIANO, KEYBOARDS, BELL, MALLET, ORGAN, ACCORDION, HARMONICA, AC.GUITAR, EL.GUITAR, DIST.GUITAR, BASS, SYNTH BASS, STRINGS, ORCHESTRA, HIT&STAB, WIND, FLUTE, AC.BRASS, SYNTH BRASS, SAX, HARD LEAD, SOFT LEAD, TECHNO SYNTH, PULSATING, SYNTH FX, OTHER SYNTH, BRIGHT PAD, SOFT PAD, VOX, PLUCKED, ETHNIC, FRETTEED, PERCUSSION, SOUND FX, BEAT&GROOVE, DRUMS, COMBINATION (0-38)

● 1-3-2.Patch Tone

Offset	Address	Size	Description	Data (Value)
	00 00	0000 000a	Tone Switch	0 - 1 (OFF, ON)
	00 01	0000 00aa	Wave Group Type	0 - 2 *1 -->
	00 02	0aaa aaaa	Wave Group ID	0 - 127 -->
#	00 03	0000 aaaa	Wave Number	0 - 254 -->
		0000 bbbb		(001 - 255)
	00 05	0000 00aa	Wave Gain	0 - 3 *2
	00 06	0000 000a	FXM Switch	0 - 1 (OFF, ON)
	00 07	0000 00aa	FXM Color	0 - 3 (1 - 4)
	00 08	0000 aaaa	FXM Depth	0 - 15 (1 - 16)
	00 09	0000 0aaa	Tone Delay Mode	0 - 7 *3
	00 0A	0aaa aaaa	Tone Delay Time	0 - 127
	00 0B	0aaa aaaa	Velocity Cross Fade	0 - 127
	00 0C	0aaa aaaa	Velocity Range Lower	1 - 127 *4
	00 0D	0aaa aaaa	Velocity Range Upper	1 - 127 *5
	00 0E	0aaa aaaa	Keyboard Range Lower	0 - 127 *6
	00 0F	0aaa aaaa	Keyboard Range Upper	0 - 127 *7
	00 10	0000 000a	Redamper Control Switch	0 - 1 (OFF, ON)
	00 11	0000 000a	Volume Control Switch	0 - 1 (OFF, ON)
	00 12	0000 000a	Hold-1 Control Switch	0 - 1 (OFF, ON)
	00 13	0000 000a	Pitch Bend Control Switch	0 - 1 (OFF, ON)
	00 14	0000 00aa	Pan Control Switch	0 - 2 *8
	00 15	000a aaaa	Controller 1 Destination 1	0 - 18 *9
	00 16	0aaa aaaa	Controller 1 Depth 1	0 - 126 (-63 - +63)
	00 17	000a aaaa	Controller 1 Destination 2	0 - 18 *9
	00 18	0aaa aaaa	Controller 1 Depth 2	0 - 126 (-63 - +63)
	00 19	000a aaaa	Controller 1 Destination 3	0 - 18 *9
	00 1A	0aaa aaaa	Controller 1 Depth 3	0 - 126 (-63 - +63)
	00 1B	000a aaaa	Controller 1 Destination 4	0 - 18 *9
	00 1C	0aaa aaaa	Controller 1 Depth 4	0 - 126 (-63 - +63)
	00 1D	000a aaaa	Controller 2 Destination 1	0 - 18 *9
	00 1E	0aaa aaaa	Controller 2 Depth 1	0 - 126 (-63 - +63)
	00 1F	000a aaaa	Controller 2 Destination 2	0 - 18 *9
	00 20	0aaa aaaa	Controller 2 Depth 2	0 - 126 (-63 - +63)
	00 21	000a aaaa	Controller 2 Destination 3	0 - 18 *9
	00 22	0aaa aaaa	Controller 2 Depth 3	0 - 126 (-63 - +63)
	00 23	000a aaaa	Controller 2 Destination 4	0 - 18 *9
	00 24	0aaa aaaa	Controller 2 Depth 4	0 - 126 (-63 - +63)
	00 25	000a aaaa	Controller 3 Destination 1	0 - 18 *9
	00 26	0aaa aaaa	Controller 3 Depth 1	0 - 126 (-63 - +63)
	00 27	000a aaaa	Controller 3 Destination 2	0 - 18 *9
	00 28	0aaa aaaa	Controller 3 Depth 2	0 - 126 (-63 - +63)
	00 29	000a aaaa	Controller 3 Destination 3	0 - 18 *9
	00 2A	0aaa aaaa	Controller 3 Depth 3	0 - 126 (-63 - +63)
	00 2B	000a aaaa	Controller 3 Destination 4	0 - 18 *9
	00 2C	0aaa aaaa	Controller 3 Depth 4	0 - 126 (-63 - +63)

Wave Group	Group Type	Group ID	Number (value)
INT-A	0	1	0 - 254 (001 - 255)
INT-B	0	2	0 - 192 (001 - 193)
<PCM	1	1 - 127	0 - 254 (001 - 255)
XP-A(Session)	2	9	0 - 205 (001 - 206)
XP-B	2	1 - 127	0 - 254 (001 - 255)

00 2D	0000 0aaa	LFO1 Waveform	0 - 7	*10
00 2E	0000 000a	LFO1 Key Sync	0 - 1	(OFF, ON)
00 2F	0aaa aaaa	LFO1 Rate	0 - 127	
00 30	0000 0aaa	LFO1 Offset	0 - 4	*11
00 31	0aaa aaaa	LFO1 Delay Time	0 - 127	
00 32	0000 00aa	LFO1 Fade Mode	0 - 3	*12
00 33	0aaa aaaa	LFO1 Fade Time	0 - 127	
00 34	0000 00aa	LFO1 External Sync	0 - 2	*13
00 35	0000 0aaa	LFO2 Waveform	0 - 7	*10
00 36	0000 000a	LFO2 Key Sync	0 - 1	(OFF, ON)
00 37	0aaa aaaa	LFO2 Rate	0 - 127	
00 38	0000 0aaa	LFO2 Offset	0 - 4	*11
00 39	0aaa aaaa	LFO2 Delay Time	0 - 127	
00 3A	0000 00aa	LFO2 Fade Mode	0 - 3	*12
00 3B	0aaa aaaa	LFO2 Fade Time	0 - 127	
00 3C	0000 00aa	LFO2 External Sync	0 - 2	*13
<hr/>				
00 3D	0aaa aaaa	Coarse Tune	0 - 96	(-48 - +48)
00 3E	0aaa aaaa	Fine Tune	0 - 100	(-50 - +50)
00 3F	000a aaaa	Random Pitch Depth	0 - 30	*14
00 40	0000 0aaa	Pitch Keyfollow	0 - 15	*15
00 41	000a aaaa	Pitch Envelope Depth	0 - 24	(-12 - +12)
00 42	0aaa aaaa	Pitch Envelope Velocity Sens	0 - 125	*16
00 43	0000 0aaa	Pitch Envelope Velocity Time1	0 - 14	*17
00 44	0000 0aaa	Pitch Envelope Velocity Time4	0 - 14	*17
00 45	0000 0aaa	Pitch Envelope Time Keyfollow	0 - 14	*17
00 46	0aaa aaaa	Pitch Envelope Time 1	0 - 127	
00 47	0aaa aaaa	Pitch Envelope Time 2	0 - 127	
00 48	0aaa aaaa	Pitch Envelope Time 3	0 - 127	
00 49	0aaa aaaa	Pitch Envelope Time 4	0 - 127	
00 4A	0aaa aaaa	Pitch Envelope Level 1	0 - 126	(-63 - +63)
00 4B	0aaa aaaa	Pitch Envelope Level 2	0 - 126	(-63 - +63)
00 4C	0aaa aaaa	Pitch Envelope Level 3	0 - 126	(-63 - +63)
00 4D	0aaa aaaa	Pitch Envelope Level 4	0 - 126	(-63 - +63)
00 4E	0aaa aaaa	Pitch LFO1 Depth	0 - 126	(-63 - +63)
00 4F	0aaa aaaa	Pitch LFO2 Depth	0 - 126	(-63 - +63)
<hr/>				
00 50	0000 0aaa	Filter Type	0 - 4	*18
00 51	0aaa aaaa	Cutoff Frequency	0 - 127	
00 52	0000 0aaa	Cutoff Keyfollow	0 - 15	*15
00 53	0aaa aaaa	Resonance	0 - 127	
00 54	0aaa aaaa	Resonance Velocity Sens	0 - 125	*16
00 55	0aaa aaaa	Filter Envelope Depth	0 - 126	(-63 - +63)
00 56	0000 0aaa	Filter Envelope Velocity Curve	0 - 6	(1 - 7)
00 57	0aaa aaaa	Filter Envelope Velocity Sens	0 - 125	*16
00 58	0000 0aaa	Filter Envelope Velocity Time1	0 - 14	*17
00 59	0000 0aaa	Filter Envelope Velocity Time4	0 - 14	*17
00 5A	0000 0aaa	Filter Envelope Time Keyfollow	0 - 14	*17
00 5B	0aaa aaaa	Filter Envelope Time 1	0 - 127	
00 5C	0aaa aaaa	Filter Envelope Time 2	0 - 127	
00 5D	0aaa aaaa	Filter Envelope Time 3	0 - 127	
00 5E	0aaa aaaa	Filter Envelope Time 4	0 - 127	
00 5F	0aaa aaaa	Filter Envelope Level 1	0 - 127	
00 60	0aaa aaaa	Filter Envelope Level 2	0 - 127	
00 61	0aaa aaaa	Filter Envelope Level 3	0 - 127	
00 62	0aaa aaaa	Filter Envelope Level 4	0 - 127	
00 63	0aaa aaaa	Filter LFO1 Depth	0 - 126	(-63 - +63)
00 64	0aaa aaaa	Filter LFO2 Depth	0 - 126	(-63 - +63)
<hr/>				
00 65	0aaa aaaa	Tone Level	0 - 127	
00 66	0000 00aa	Bias Direction	0 - 3	*19
00 67	0aaa aaaa	Bias Position	0 - 127	(C-1 - G9)
00 68	0000 0aaa	Bias Level	0 - 14	*17
00 69	0000 0aaa	Level Envelope Velocity Curve	0 - 6	(1 - 7)
00 6A	0aaa aaaa	Level Envelope Velocity Sens	0 - 125	*16
00 6B	0000 0aaa	Level Envelope Velocity Time1	0 - 14	*17
00 6C	0000 0aaa	Level Envelope Velocity Time4	0 - 14	*17
00 6D	0000 0aaa	Level Envelope Time Keyfollow	0 - 14	*17
00 6E	0aaa aaaa	Level Envelope Time 1	0 - 127	
00 6F	0aaa aaaa	Level Envelope Time 2	0 - 127	
00 70	0aaa aaaa	Level Envelope Time 3	0 - 127	
00 71	0aaa aaaa	Level Envelope Time 4	0 - 127	
00 72	0aaa aaaa	Level Envelope Level 1	0 - 127	
00 73	0aaa aaaa	Level Envelope Level 2	0 - 127	
00 74	0aaa aaaa	Level Envelope Level 3	0 - 127	
00 75	0aaa aaaa	Level LFO1 Depth	0 - 126	(-63 - +63)
00 76	0aaa aaaa	Level LFO2 Depth	0 - 126	(-63 - +63)
00 77	0aaa aaaa	Tone Pan	0 - 127	(L64 - 63R)
00 78	0000 0aaa	Pan KeyFollow	0 - 14	*17
00 79	00aa aaaa	Random Pan Depth	0 - 63	
00 7A	0aaa aaaa	Alternate Pan Depth	1 - 127	(L63 - 63R)
00 7B	0aaa aaaa	Pan LFO1 Depth	0 - 126	(L63 - 63R)
00 7C	0aaa aaaa	Pan LFO2 Depth	0 - 126	(L63 - 63R)
<hr/>				
00 7D	0000 00aa	Output Assign	0 - 3	*20
00 7E	0aaa aaaa	Mix/EFX Send Level	0 - 127	
00 7F	0aaa aaaa	Chorus Send Level	0 - 127	
01 00	0aaa aaaa	Reverb Send Level	0 - 127	
<hr/>				
Total size	00 00 01 01			

- *1 INT, <PCM>, EXP
- *2 -6, 0, +6, +12
- *3 NORMAL, HOLD, PLAYMATE, CLOCK-SYNC, <TAP-SYNC>, KEY-OFF-N, KEY-OFF-D, TEMPO-SYNC
- *4 1-Upper
- *5 Lower-127
- *6 C-1-Upper
- *7 Lower-G9
- *8 OFF, CONTINUOUS, KEY-ON
- *9 OFF, PCH, CUT, RES, LEV, PAN, MIX, CHO, REV, PL1, PL2, FL1, FL2, AL1, AL2, pL1, pL2, L1R, L2R
- *10 TRI, SIN, SAW, SQR, TRP, S&H, RND, CHS
- *11 -100, -50, 0, +50, +100
- *12 KEY-ON-IN, KEY-ON-OUT, KEY-OFF-IN, KEY-OFF-OUT
- *13 OFF, CLOCK, <TAP>
- *14 0, 1, 2, 3, 4, 5, 6, 7, 8, 9, 10, 20, 30, 40, 50, 60, 70, 80, 90, 100, 200, 300, 400, 500, 600, 700, 800, 900, 1000, 1100, 1200
- *15 -100, -70, -50, -30, -10, 0, +10, +20, +30, +40, +50, +70, +100, +120, +150, +200

MIDI Implementation

*16 -100+150

*17 -100, -70, -50, -40, -30, -20, -10, 0, +10, +20, +30, +40, +50, +70, +100

*18 OFF, LPF, BPF, HPF, PKG

*19 LOWER, UPPER, LOWER&UPPER, ALL

*20 MIX, EFX, <DIRECT-1>, <DIRECT-2>

1-4.Rhythm Setup

Offset Address	Description	
00 00	Rhythm Common	1-4-1
23 00	Rhythm Note for Key# 35	1-4-2
24 00	Rhythm Note for Key# 36	
:		
62 00	Rhythm Note for Key# 98	

1-4-1.Rhythm Common

Offset Address	Size	Description	Data (Value)
00 00	0aaa aaaa	Rhythm Name 1	32 - 127
00 01	0aaa aaaa	Rhythm Name 2	32 - 127
00 02	0aaa aaaa	Rhythm Name 3	32 - 127
00 03	0aaa aaaa	Rhythm Name 4	32 - 127
00 04	0aaa aaaa	Rhythm Name 5	32 - 127
00 05	0aaa aaaa	Rhythm Name 6	32 - 127
00 06	0aaa aaaa	Rhythm Name 7	32 - 127
00 07	0aaa aaaa	Rhythm Name 8	32 - 127
00 08	0aaa aaaa	Rhythm Name 9	32 - 127
00 09	0aaa aaaa	Rhythm Name 10	32 - 127
00 0A	0aaa aaaa	Rhythm Name 11	32 - 127
00 0B	0aaa aaaa	Rhythm Name 12	32 - 127
Total size	00 00 00 0C		

1-4-2.Rhythm Note

Offset Address	Size	Description	Data (Value)
00 00	0000 000a	Tone Switch	0 - 1 (OFF,ON)
00 01	0000 00aa	Wave Group Type	0 - 2 *1 ->
00 02	0aaa aaaa	Wave Group ID	0 - 127 ->
00 03	0000 aaaa	Wave Number	0 - 254 ->
	0000 bbbb		001 - 255
00 05	0000 00aa	Wave Gain	0 - 3 *2
00 06	0000 aaaa	Bend Range	0 - 12
00 07	000a aaaa	Mute Group	0 - 31 (OFF,1 - 31)
00 08	0000 000a	Envelope Mode	0 - 1 *3
00 09	0000 000a	Volume Control Switch	0 - 1 (OFF,ON)
00 0A	0000 000a	Hold-1 Control Switch	0 - 1 (OFF,ON)
00 0B	0000 00aa	Pan Control Switch	0 - 2 *4
00 0C	0aaa aaaa	Coarse Tune	0 - 127 (C-1 - G9)
00 0D	0aaa aaaa	Fine Tune	0 - 100 (-50 - +50)
00 0E	000a aaaa	Random Pitch Depth	0 - 30 *5
00 0F	000a aaaa	Pitch Envelope Depth	0 - 24 (-12 - +12)
00 10	0aaa aaaa	Pitch Envelope Velocity Sens	0 - 125 *6
00 11	0000 aaaa	Pitch Envelope Velocity Time	0 - 14 *7
00 12	0aaa aaaa	Pitch Envelope Time 1	0 - 127
00 13	0aaa aaaa	Pitch Envelope Time 2	0 - 127
00 14	0aaa aaaa	Pitch Envelope Time 3	0 - 127
00 15	0aaa aaaa	Pitch Envelope Time 4	0 - 127
00 16	0aaa aaaa	Pitch Envelope Level 1	0 - 126 (-63 - +63)
00 17	0aaa aaaa	Pitch Envelope Level 2	0 - 126 (-63 - +63)
00 18	0aaa aaaa	Pitch Envelope Level 3	0 - 126 (-63 - +63)
00 19	0aaa aaaa	Pitch Envelope Level 4	0 - 126 (-63 - +63)
00 1A	0000 0aaa	Filter Type	0 - 4 *8
00 1B	0aaa aaaa	Cutoff Frequency	0 - 127
00 1C	0aaa aaaa	Resonance	0 - 127
00 1D	0aaa aaaa	Resonance Velocity Sens	0 - 125 *6
00 1E	0aaa aaaa	Filter Envelope Depth	0 - 126 (-63 - +63)
00 1F	0aaa aaaa	Filter Envelope Velocity Sens	0 - 125 *6
00 20	0000 aaaa	Filter Envelope Velocity Time	0 - 14 *7
00 21	0aaa aaaa	Filter Envelope Time 1	0 - 127
00 22	0aaa aaaa	Filter Envelope Time 2	0 - 127
00 23	0aaa aaaa	Filter Envelope Time 3	0 - 127
00 24	0aaa aaaa	Filter Envelope Time 4	0 - 127
00 25	0aaa aaaa	Filter Envelope Level 1	0 - 127
00 26	0aaa aaaa	Filter Envelope Level 2	0 - 127
00 27	0aaa aaaa	Filter Envelope Level 3	0 - 127
00 28	0aaa aaaa	Filter Envelope Level 4	0 - 127
00 29	0aaa aaaa	Tone Level	0 - 127
00 2A	0aaa aaaa	Level Envelope Velocity Sens	0 - 125 *6
00 2B	0000 aaaa	Level Envelope Velocity Time	0 - 14 *7
00 2C	0aaa aaaa	Level Envelope Time 1	0 - 127
00 2D	0aaa aaaa	Level Envelope Time 2	0 - 127
00 2E	0aaa aaaa	Level Envelope Time 3	0 - 127
00 2F	0aaa aaaa	Level Envelope Time 4	0 - 127
00 30	0aaa aaaa	Level Envelope Level 1	0 - 127
00 31	0aaa aaaa	Level Envelope Level 2	0 - 127
00 32	0aaa aaaa	Level Envelope Level 3	0 - 127
00 33	0aaa aaaa	Tone Pan	0 - 127 (L64 - 63R)
00 34	00aa aaaa	Random Pan Depth	0 - 63
00 35	0aaa aaaa	Alternate Pan Depth	1 - 127 (L63 - 63R)
00 36	0000 00aa	Output Assign	0 - 3 *9
00 37	0aaa aaaa	Mix/EFX Send Level	0 - 127
00 38	0aaa aaaa	Chorus Send Level	0 - 127
00 39	0aaa aaaa	Reverb Send Level	0 - 127
Total size	00 00 00 3A		

Wave Group	Group Type	Group ID	Number (value)
INT-A	0	1	0 - 254 (001 - 255)
INT-B	0	2	0 - 192 (001 - 193)
<PCM	1	1 - 127	0 - 254 (001 - 255)>
XP-A(Session)	2	9	0 - 205 (001 - 206)
XP-B	2	1 - 127	0 - 254 (001 - 255)

- *1 INT, <PCM>, EXP
- *2 -6, 0, +6, +12
- *3 NO-SUS, SUSTAIN
- *4 OFF, CONTINUOUS, KEY-ON
- *5 0, 1, 2, 3, 4, 5, 6, 7, 8, 9, 10, 20, 30, 40, 50, 60, 70, 80, 90, 100, 200, 300, 400, 500, 600, 700, 800, 900, 1000, 1100, 1200
- *6 -100+150
- *7 -100, -70, -50, -40, -30, -20, -10, 0, +10, +20, +30, +40, +50, +70, +100
- *8 OFF, LPF, BPF, HPF, PKG
- *9 MIX, EFX, <DIRECT-1>, <DIRECT-2>

■ Address Block Map

The following is an outline of the address map for Exclusive messages.

Address(H)	Block	Sub Block	Reference
00 00 00 00	System common		1-1-1
	Scale tune	Part 1	1-1-2
		:	
		Part 16	
		Patch	
01 00 00 00	Temporary performance	Common	1-2-1
		Part 1	1-2-2
		:	
		Part 16	
02 00 00 00	Performance mode temporary patch	Part 1	Common 1-3-1
		:	Tone 1 1-3-2
		Part 9	:
			Tone 4
02 09 00 00	Temporary rhythm setup	Common	1-4-1
		Note# 35	1-4-2
		:	
		Note# 98	
02 0A 00 00	Performance mode temporary patch	Part 11	Common 1-3-1
		:	Tone 1 1-3-2
		Part 16	:
			Tone 4
03 00 00 00	Patch mode temporary patch	Common	1-3-1
		Tone 1	1-3-2
		:	
		Tone 4	
10 00 00 00	User performance	USER:01	Common 1-2-1
		:	Part 1 1-2-2
		USER:32	:
			Part 16
10 40 00 00	User rhythm setup	USER:1	Common 1-4-1
		USER:2	Note# 35 1-4-2
		:	
			Note# 98
11 00 00 00	User patch	USER:001	Common 1-3-1
		:	Tone 1 1-3-2
		USER:128	:
			Tone 4

MIDI Implementation

2. GS (Model ID = 42H)

Start address	Description
40 10 00	Scale Tune Part10 2-1
40 11 00	: Part1
40 12 00	: Part2
40 13 00	: Part3
40 14 00	: Part4
40 15 00	: Part5
40 16 00	: Part6
40 17 00	: Part7
40 18 00	: Part8
40 19 00	: Part9
40 1A 00	: Part11
40 1B 00	: Part12
40 1C 00	: Part13
40 1D 00	: Part14
40 1E 00	: Part15
40 1F 00	: Part16

● 2-1.Scale Tune

Offset Address	Description
40	0aaa aaaa Scale Tune for C 0 - 127 (-64 - +63)
41	0aaa aaaa Scale Tune for C# 0 - 127 (-64 - +63)
42	0aaa aaaa Scale Tune for D 0 - 127 (-64 - +63)
43	0aaa aaaa Scale Tune for D# 0 - 127 (-64 - +63)
44	0aaa aaaa Scale Tune for E 0 - 127 (-64 - +63)
45	0aaa aaaa Scale Tune for F 0 - 127 (-64 - +63)
46	0aaa aaaa Scale Tune for F# 0 - 127 (-64 - +63)
47	0aaa aaaa Scale Tune for G 0 - 127 (-64 - +63)
48	0aaa aaaa Scale Tune for G# 0 - 127 (-64 - +63)
49	0aaa aaaa Scale Tune for A 0 - 127 (-64 - +63)
4A	0aaa aaaa Scale Tune for A# 0 - 127 (-64 - +63)
4B	0aaa aaaa Scale Tune for B 0 - 127 (-64 - +63)
Total Size	00 00 0C

* In order for a GS Exclusive message to be correctly received by the JV-1010, the starting address of the message must be the Start address of each Part (the address of Scale Tune C, i.e., offset 40).

4. Supplementary Material

■ Correspondence of the EFX algorithm and Exclusive Address (EFX Parameter 1–12)

EFX	Parameter	Value
-----	-----------	-------

● Type01: STEREO-EQ

prm1	Low Frequency	0 - 1
prm2	Low Gain	0 - 30
prm3	High Frequency	0 - 1
prm4	H1 Gain	0 - 30
prm5	Peaking1 Frequency	0 - 16
prm6	Peaking1 Q	0 - 4
prm7	Peaking1 Gain	0 - 30
prm8	Peaking2 Frequency	0 - 16
prm9	Peaking2 Q	0 - 4
prm10	Peaking2 Gain	0 - 30
prm11	Level	0 - 127

● Type02: OVERDRIVE

prm1	Drive	0 - 127
prm2	Output Pan	0 - 127
prm3	Amp Simulator Type	0 - 3
prm4	Low Gain	0 - 30
prm5	High Gain	0 - 30
prm6	Output Level	0 - 127

● Type03: DISTORTION

prm1	Drive	0 - 127
prm2	Output Pan	0 - 127
prm3	Amp Simulator Type	0 - 3
prm4	Low Gain	0 - 30
prm5	High Gain	0 - 30
prm6	Output Level	0 - 127

● Type04: PHASER

prm1	Manual	0 - 125
prm2	Rate	0 - 125
prm3	Depth	0 - 127
prm4	Resonance	0 - 127
prm5	Mix Level	0 - 127
prm6	Output Pan	0 - 127
prm7	Output Level	0 - 127

● Type05: SPECTRUM

prm1	Band1 Gain	0 - 30
prm2	Band2 Gain	0 - 30
prm3	Band3 Gain	0 - 30
prm4	Band4 Gain	0 - 30
prm5	Band5 Gain	0 - 30
prm6	Band6 Gain	0 - 30
prm7	Band7 Gain	0 - 30
prm8	Band8 Gain	0 - 30
prm9	Q	0 - 4
prm10	Output Pan	0 - 127
prm11	Output Level	0 - 127

● Type06: ENHANCER

prm1	Sens	0 - 127
prm2	Mix Level	0 - 127
prm3	Low Gain	0 - 30
prm4	High Gain	0 - 30
prm5	Output Level	0 - 127

● Type07: AUTO-WAH

prm1	Filter Type	0 - 1
prm2	Rate	0 - 125
prm3	Depth	0 - 127
prm4	Sens	0 - 127
prm5	Manual	0 - 127
prm6	Peak	0 - 127
prm7	Output Level	0 - 127

● Type08: ROTARY

prm1	High Frequency Slow Rate	0 - 125
prm2	Low Frequency Slow Rate	0 - 125
prm3	High Frequency Fast Rate	0 - 125
prm4	Low Frequency Fast Rate	0 - 125
prm5	Speed	0 - 1
prm6	High Frequency Acceleration	0 - 15
prm7	Low Frequency Acceleration	0 - 15
prm8	High Frequency Level	0 - 127
prm9	Low Frequency Level	0 - 127
prm10	Separation	0 - 127
prm11	Output Level	0 - 127

● Type09: COMPRESSOR

prm1	Sustain	0 - 127
prm2	Attack	0 - 127
prm3	Output Pan	0 - 127
prm4	Post Gain	0 - 3
prm5	Low Gain	0 - 30
prm6	High Gain	0 - 30
prm7	Output Level	0 - 127

● Type10: LIMITER

prm1	Threshold Level	0 - 127
prm2	Release Time	0 - 127
prm3	Compression Ratio	0 - 3
prm4	Output Pan	0 - 127
prm5	Post Gain	0 - 3
prm6	Low Gain	0 - 30
prm7	High Gain	0 - 30
prm8	Output Level	0 - 127

● Type11: HEXA-CHORUS

prm1	Pre Delay Time	0 - 125
prm2	Rate	0 - 125
prm3	Depth	0 - 127
prm4	Pre Delay Deviation	0 - 20
prm5	Depth Deviation	0 - 40
prm6	Pan Deviation	0 - 20
prm7	Effect Balance	0 - 100
prm8	Output Level	0 - 127

● Type12: TREMOLO-CHORUS

prm1	Pre Delay Time	0 - 125
prm2	Chorus Rate	0 - 125
prm3	Chorus Depth	0 - 127
prm4	Tremolo Rate	0 - 125
prm5	Tremolo Separation	0 - 127
prm6	Tremolo Phase	0 - 90
prm7	Effect Balance	0 - 100
prm8	Output Level	0 - 127

● Type13: SPACE-D

prm1	Pre Delay Time	0 - 125
prm2	Rate	0 - 125
prm3	Depth	0 - 127
prm4	Phase	0 - 90
prm5	Low Gain	0 - 30
prm6	High Gain	0 - 30
prm7	Effect Balance	0 - 100
prm8	Output Level	0 - 127

● Type14: STEREO-CHORUS

prm1	Filter Type	0 - 2
prm2	Cutoff Frequency	0 - 16
prm3	Pre Delay Time	0 - 125
prm4	Rate	0 - 125
prm5	Depth	0 - 127
prm6	Phase	0 - 90
prm7	(not used)	
prm8	Low Gain	0 - 30
prm9	High Gain	0 - 30
prm10	Effect Balance	0 - 100
prm11	Output Level	0 - 127

● Type15: STEREO-FLANGER

prm1	Filter Type	0 - 2
prm2	Cutoff Frequency	0 - 16
prm3	Pre Delay Time	0 - 125
prm4	Rate	0 - 125
prm5	Depth	0 - 127
prm6	Phase	0 - 90
prm7	Feedback Level	0 - 98
prm8	Low Gain	0 - 30
prm9	High Gain	0 - 30
prm10	Effect Balance	0 - 100
prm11	Output Level	0 - 127

● Type16: STEP-FLANGER

prm1	Pre Delay Time	0 - 125
prm2	Rate	0 - 125
prm3	Depth	0 - 127
prm4	Feedback Level	0 - 98
prm5	Step Rate	0 - 125
prm6	Phase	0 - 90
prm7	Low Gain	0 - 30
prm8	High Gain	0 - 30
prm9	Effect Balance	0 - 100
prm10	Output Level	0 - 127

MIDI Implementation

● Type17: STEREO-DELAY

prm1	Feedback Mode	0 - 1
prm2	Delay Time Left	0 - 126
prm3	Delay Time Right	0 - 126
prm4	Feedback Phase Left	0 - 1
prm5	Feedback Phase Right	0 - 1
prm6	Feedback Level	0 - 98
prm7	HF Damp	0 - 17
prm8	Low Gain	0 - 30
prm9	High Gain	0 - 30
prm10	Effect Balance	0 - 100
prm11	Output Level	0 - 127

● Type18: MODULATION-DELAY

prm1	Feedback Mode	0 - 1
prm2	Delay Time Left	0 - 126
prm3	Delay Time Right	0 - 126
prm4	Feedback Level	0 - 98
prm5	HF Damp	0 - 17
prm6	Rate	0 - 125
prm7	Depth	0 - 127
prm8	Phase	0 - 90
prm9	Low Gain	0 - 30
prm10	High Gain	0 - 30
prm11	Effect Balance	0 - 100
prm12	Output Level	0 - 127

● Type19: TRIPLE-TAP-DELAY

prm1	Delay Time Left	0 - 125
prm2	Delay Time Right	0 - 125
prm3	Delay Time Center	0 - 125
prm4	Feedback Level	0 - 98
prm5	HF Damp	0 - 17
prm6	Left Level	0 - 127
prm7	Right Level	0 - 127
prm8	Center Level	0 - 127
prm9	Low Gain	0 - 30
prm10	High Gain	0 - 30
prm11	Effect Balance	0 - 100
prm12	Output Level	0 - 127

● Type20: QUADRUPLE-TAP-DELAY

prm1	Delay Time 1	0 - 125
prm2	Delay Time 2	0 - 125
prm3	Delay Time 3	0 - 125
prm4	Delay Time 4	0 - 125
prm5	Level 1	0 - 127
prm6	Level 2	0 - 127
prm7	Level 3	0 - 127
prm8	Level 4	0 - 127
prm9	Feedback Level	0 - 98
prm10	HF Damp	0 - 17
prm11	Effect Balance	0 - 100
prm12	Output Level	0 - 127

● Type21: TIME-CONTROL-DELAY

prm1	Delay Time	0 - 120
prm2	Feedback Level	0 - 98
prm3	Acceleration	0 - 15
prm4	HF Damp	0 - 17
prm5	Output Pan	0 - 127
prm6	Low Gain	0 - 30
prm7	High Gain	0 - 30
prm8	Effect Balance	0 - 100
prm9	Output Level	0 - 127

● Type22: 2VOICE-PITCH-SHIFTER

prm1	Pitch Shifter Mode	0 - 4
prm2	Coarse Pitch A	0 - 36
prm3	Coarse Pitch B	0 - 36
prm4	Fine Pitch A	0 - 100
prm5	Fine Pitch B	0 - 100
prm6	Pre Delay Time A	0 - 126
prm7	Pre Delay Time B	0 - 126
prm8	Output Pan A	0 - 127
prm9	Output Pan B	0 - 127
prm10	Level Balance	0 - 100
prm11	Effect Balance	0 - 100
prm12	Output Level	0 - 127

● Type23: FBK-PITCH-SHIFTER

prm1	Pitch Shifter Mode	0 - 4
prm2	Coarse Pitch	0 - 36
prm3	Fine Pitch	0 - 100
prm4	Pre Delay Time	0 - 126
prm5	Feedback Level	0 - 98
prm6	Output Pan	0 - 127
prm7	Low Gain	0 - 30
prm8	High Gain	0 - 30
prm9	Effect Balance	0 - 100
prm10	Output Level	0 - 127

● Type24: REVERB

prm1	Reverb Type	0 - 5
prm2	Pre Delay Time	0 - 125
prm3	Gate Time	0 - 127
prm4	HF Damp	0 - 17
prm5	Low Gain	0 - 30
prm6	High Gain	0 - 30
prm7	Effect Balance	0 - 100
prm8	Output Level	0 - 127

● Type25: GATE-REVERB

prm1	Gate-Reverb Type	0 - 3
prm2	Pre Delay Time	0 - 125
prm3	Gate Time	0 - 99
prm4	Low Gain	0 - 30
prm5	High Gain	0 - 30
prm6	Effect Balance	0 - 100
prm7	Output Level	0 - 127

● Type26: OVERDRIVE→CHORUS (serial)

prm1	Drive	0 - 127
prm2	Over Drive Pan	0 - 127
prm3	Chorus Pre Delay Time	0 - 125
prm4	Chorus Rate	0 - 125
prm5	Chorus Depth	0 - 127
prm6	(not used)	
prm7	Chorus Balance	0 - 100
prm8	Output Level	0 - 127

● Type27: OVERDRIVE→FLANGER (serial)

prm1	Drive	0 - 127
prm2	Over Drive Pan	0 - 127
prm3	Flanger Pre Delay Time	0 - 125
prm4	Flanger Rate	0 - 125
prm5	Flanger Depth	0 - 127
prm6	Flanger Feedback Level	0 - 98
prm7	Flanger Balance	0 - 100
prm8	Output Level	0 - 127

● Type28: OVERDRIVE→DELAY (serial)

prm1	Drive	0 - 127
prm2	Over Drive Pan	0 - 127
prm3	Delay Time	0 - 126
prm4	Delay Feedback Level	0 - 98
prm5	Delay HF Damp	0 - 17
prm6	Delay Balance	0 - 100
prm7	Output Level	0 - 127

● Type29: DISTORTION→CHORUS (serial)

prm1	Distortion Drive	0 - 127
prm2	Distortion Pan	0 - 127
prm3	Chorus Pre Delay Time	0 - 125
prm4	Chorus Rate	0 - 125
prm5	Chorus Depth	0 - 127
prm6	(not used)	
prm7	Chorus Balance	0 - 100
prm8	Output Level	0 - 127

● Type30: DISTORTION→FLANGER (serial)

prm1	Distortion Drive	0 - 127
prm2	Distortion Pan	0 - 127
prm3	Flanger Pre Delay Time	0 - 125
prm4	Flanger Rate	0 - 125
prm5	Flanger Depth	0 - 127
prm6	Flanger Feedback Level	0 - 98
prm7	Flanger Balance	0 - 100
prm8	Output Level	0 - 127

● Type31: DISTORTION→DELAY (serial)

prm1	Distortion Drive	0 - 127
prm2	Distortion Pan	0 - 127
prm3	Delay Time	0 - 126
prm4	Delay Feedback Level	0 - 98
prm5	Delay HF Damp	0 - 17
prm6	Delay Balance	0 - 100
prm7	Output Level	0 - 127

● Type32: ENHANCER→CHORUS (serial)

prm1	Enhancer Sens	0 - 127
prm2	Enhancer Mix Level	0 - 127
prm3	Chorus Pre Delay Time	0 - 125
prm4	Chorus Rate	0 - 125
prm5	Chorus Depth	0 - 127
prm6	(not used)	
prm7	Chorus Balance	0 - 100
prm8	Output Level	0 - 127

● Type33: ENHANCER→FLANGER (serial)

prm1	Enhancer Sens	0 - 127
prm2	Enhancer Mix Level	0 - 127
prm3	Flanger Pre Delay Time	0 - 125
prm4	Flanger Rate	0 - 125
prm5	Flanger Depth	0 - 127
prm6	Flanger Feedback Level	0 - 98
prm7	Flanger Balance	0 - 100
prm8	Output Level	0 - 127

● Type34: ENHANCER→DELAY (serial)

prm1	Enhancer Sens	0 - 127
prm2	Enhancer Mix Level	0 - 127
prm3	Delay Time	0 - 126
prm4	Delay Feedback Level	0 - 98
prm5	Delay HF Damp	0 - 17
prm6	(not used)	
prm7	Delay Balance	0 - 100
prm8	Output Level	0 - 127

● Type35: CHORUS→DELAY (serial)

prm1	Chorus Pre Delay Time	0 - 125
prm2	Chorus Rate	0 - 125
prm3	Chorus Depth	0 - 127
prm4	(not used)	
prm5	Chorus Balance	0 - 100
prm6	Delay Time	0 - 126
prm7	Delay Feedback Level	0 - 98
prm8	Delay HF Damp	0 - 17
prm9	Delay Balance	0 - 100
prm10	Output Level	0 - 127

● Type36: FLANGER→DELAY (serial)

prm1	Flanger Pre Delay Time	0 - 125
prm2	Flanger Rate	0 - 125
prm3	Flanger Depth	0 - 127
prm4	Flanger Feedback Level	0 - 98
prm5	Flanger Balance	0 - 100
prm6	Delay Time	0 - 126
prm7	Delay Feedback Level	0 - 98
prm8	Delay HF Damp	0 - 17
prm9	Delay Balance	0 - 100
prm10	Output Level	0 - 127

● Type37: CHORUS→FLANGER (serial)

prm1	Chorus Pre Delay Time	0 - 125
prm2	Chorus Rate	0 - 125
prm3	Chorus Depth	0 - 127
prm4	Chorus Balance	0 - 100
prm5	Flanger Pre Delay Time	0 - 125
prm6	Flanger Rate	0 - 125
prm7	Flanger Depth	0 - 127
prm8	Flanger Feedback Level	0 - 98
prm9	Flanger Balance	0 - 100
prm10	Output Level	0 - 127

● Type38: CHORUS/DELAY (parallel)

prm1	Chorus Pre Delay Time	0 - 125
prm2	Chorus Rate	0 - 125
prm3	Chorus Depth	0 - 127
prm4	(not used)	
prm5	Chorus Balance	0 - 100
prm6	Delay Time	0 - 126
prm7	Delay Feedback Level	0 - 98
prm8	Delay HF Damp	0 - 17
prm9	Delay Balance	0 - 100
prm10	Output Level	0 - 127

● Type39: FLANGER/DELAY (parallel)

prm1	Flanger Pre Delay Time	0 - 125
prm2	Flanger Rate	0 - 125
prm3	Flanger Depth	0 - 127
prm4	Flanger Feedback Level	0 - 98
prm5	Flanger Balance	0 - 100
prm6	Delay Time	0 - 126
prm7	Delay Feedback Level	0 - 98
prm8	Delay HF Damp	0 - 17
prm9	Delay Balance	0 - 100
prm10	Output Level	0 - 127

● Type40: CHORUS/FLANGER (parallel)

prm1	Chorus Pre Delay Time	0 - 125
prm2	Chorus Rate	0 - 125
prm3	Chorus Depth	0 - 127
prm4	Chorus Balance	0 - 100
prm5	Flanger Pre Delay Time	0 - 125
prm6	Flanger Rate	0 - 125
prm7	Flanger Depth	0 - 127
prm8	Flanger Feedback Level	0 - 98
prm9	Flanger Balance	0 - 100
prm10	Output Level	0 - 127

■ Decimal/Hexadecimal Table (hexadecimal values are indicated by a following "H")

MIDI uses 7-bit hexadecimal values to indicate data values and the address and size of exclusive messages. The following table shows the correspondence between decimal and hexadecimal numbers.

D	H	D	H	D	H	D	H
0	00H	32	20H	64	40H	96	60H
1	01H	33	21H	65	41H	97	61H
2	02H	34	22H	66	42H	98	62H
3	03H	35	23H	67	43H	99	63H
4	04H	36	24H	68	44H	100	64H
5	05H	37	25H	69	45H	101	65H
6	06H	38	26H	70	46H	102	66H
7	07H	39	27H	71	47H	103	67H
8	08H	40	28H	72	48H	104	68H
9	09H	41	29H	73	49H	105	69H
10	0AH	42	2AH	74	4AH	106	6AH
11	0BH	43	2BH	75	4BH	107	6BH
12	0CH	44	2CH	76	4CH	108	6CH
13	0DH	45	2DH	77	4DH	109	6DH
14	0EH	46	2EH	78	4EH	110	6EH
15	0FH	47	2FH	79	4FH	111	6FH
16	10H	48	30H	80	50H	112	70H
17	11H	49	31H	81	51H	113	71H
18	12H	50	32H	82	52H	114	72H
19	13H	51	33H	83	53H	115	73H
20	14H	52	34H	84	54H	116	74H
21	15H	53	35H	85	55H	117	75H
22	16H	54	36H	86	56H	118	76H
23	17H	55	37H	87	57H	119	77H
24	18H	56	38H	88	58H	120	78H
25	19H	57	39H	89	59H	121	79H
26	1AH	58	3AH	90	5AH	122	7AH
27	1BH	59	3BH	91	5BH	123	7BH
28	1CH	60	3CH	92	5CH	124	7CH
29	1DH	61	3DH	93	5DH	125	7DH
30	1EH	62	3EH	94	5EH	126	7EH
31	1FH	63	3FH	95	5FH	127	7FH

D: decimal
H: hexadecimal

- * Decimal expressions such as used for MIDI channel, Bank Select, and Program Change will be the value 1 greater than the decimal value given in the above table.
- * Since each MIDI byte carries 7 significant data bits, each byte can express a maximum of 128 different values. Data for which higher resolution is required must be transmitted using two or more bytes. For example a value indicated as a two-byte value of aa bbH would have a value of aa x 128 + bb.
- * For a signed number (+/-), 00H = -64, 40H = +/-0, and 7FH = +63. I.e., the decimal equivalent will be 64 less than the decimal value given in the above table. For a two-byte signed number, 00 00H = -8192, 40 00H = +/-0, and 7F 7FH = +8191. For example the decimal expression of aa bbH would be aa bbH - 40 00H = (aa x 128 + bb - 64 x 128).
- * Hexadecimal notation in two 4-bit units is used for data indicated as "nibbled". The nibbled two-byte value of 0a 0b H would be a x 16 + b.

<Example 1> What is the decimal equivalent of 5AH?
From the above table, 5AH = 90.

<Example 2> What is the decimal equivalent of the 7-bit hexadecimal values 12 34H?
From the above table, 12H = 18 and 34H = 52
Thus, 18 x 128 + 52 = 2356

<Example 3> What is the decimal equivalent of the nibbled expression 0A 03 09 0DH?
From the above table, 0AH = 10, 03H = 3, 09H = 9, 0DH = 13
Thus, the result is ((10 x 16 + 3) x 16 + 9) x 16 + 13 = 41885

<Example 4> What is the nibbled equivalent of the decimal number 1258?

16)	1258	
16)	78	..10
16)	4	..14
		0	..4

From the above table, 0=00H, 4=04H, 14=0EH, 10=0AH
Thus the result is 00 04 0E 0AH

MIDI Implementation

Examples of Actual MIDI Messages

<Example 1> 92 3E 5F

9n is the Note On status and 'n' is the MIDI channel number. Since 2H = 2, 3EH = 62, and 5FH = 95, this is a Note On message of MIDI CH = 3, note number 62 (note name D4) and velocity 95.

<Example 2> CE 49

CnH is the Program Change status and 'n' is the MIDI channel number. Since EH = 14, and 49H = 73, this is a Program Change message of MIDI CH = 15, Program number 74 (in the GS sound map, Flute).

<Example 3> EA 00 28

EnH is the Pitch Bend Change status and 'n' is the MIDI channel number. The 2nd byte (00H=0) is the LSB of the Pitch Bend value, and the 3rd byte (28H=40) is the MSB. However since the Pitch Bend is a signed number with 0 at 40 00H (= 64 x 128 + 0 = 8192), the Pitch Bend value in this case is 28 00H - 40 00H = 40 x 128 + 0 - (64 x 128 + 0) = 5120 - 8192 = -3072

If we assume that the Pitch Bend Sensitivity is set to two semitones, the pitch will change only -200 cents for a Pitch Bend value of -8192 (00 00H). Thus, this message is specifying a Pitch Bend of $-200 \times (-3072) / (-8192) = -75$ cents on MIDI CH = 11.

<Example 4> B3 64 00 65 00 06 0C 26 00 64 7F 65 7F

BnH is the Control Change status, and 'n' is the MIDI channel number. In Control Change messages, the 2nd byte is the controller number, and the 3rd byte is the parameter value. MIDI allows what is known as "running status," when if messages of the same status follow each other, it is permitted to omit the second and following status bytes. In the message above, running status is being used, meaning that the message has the following content.

B3 64 00	MIDI CH = 4, RPN parameter number LSB: 00H
(B3) 65 00	MIDI CH = 4, RPN parameter number MSB: 00H
(B3) 06 0C	MIDI CH = 4, parameter value MSB: 0CH
(B3) 26 00	MIDI CH = 4, parameter value LSB: 00H
(B3) 64 7F	MIDI CH = 4, RPN parameter number LSB: 7FH
(B3) 65 7F	MIDI CH = 4, RPN parameter number MSB: 7FH

Thus, this message transmits a parameter value of 0C 00H to RPN parameter number 00 00H on MIDI CH = 4, and then sets the RPN parameter number to 7F 7FH.

The function assigned to RPN parameter number 00 00H is Pitch Bend Sensitivity, and the MSB of the parameter value indicates semitone steps. Since the MSB of this parameter value is 0CH = 12, the maximum width of pitch bend is being set to [+/-] 12 semitones (1 octave) (GS sound sources ignore the LSB of Pitch Bend Sensitivity, but it is best to transmit the LSB (parameter value 0) as well, so that the message can be correctly received by any device.

Once the parameter number has been set for RPN or NRPN, all subsequent Data Entry messages on that channel will be effective. Thus, it is recommended that after you have made the change you want, you set the parameter number to 7F 7FH (an "unset" or "null" setting). The final (B3) 64 7F (B3) 65 7F is for this purpose.

It is not a good idea to store many events within the data of a song (e.g., a Standard MIDI File song) using running status as shown in <Example 4>. When the song is paused, fast-forwarded or rewound, the sequencer may not be able to transmit the proper status, causing the sound source to misinterpret the data. It is best to attach the proper status byte to all events.

It is also important to transmit RPN or NRPN parameter number settings and parameter values in the correct order. In some sequencers, data events recorded in the same clock (or a nearby clock) can sometimes be transmitted in an order other than the order in which they were recorded. It is best to record such events at an appropriate interval (1 tick at TPQN=96, or 5 ticks at TPQN=480).

* TPQN: Ticks Per Quarter Note (i.e., the time resolution of the sequencer)

Examples of Exclusive Messages and Calculating the Checksum

Roland exclusive messages (RQ1, DT1) are transmitted with a checksum at the end of the data (before F7) to check that the data was received correctly. The value of the checksum is determined by the address and data (or size) of the exclusive message.

How to Calculate the Checksum

(hexadecimal values are indicated by a "H")

The checksum consists of a value whose lower 7 bits are 0 when the address, size and checksum itself are added.

The following formula shows how to calculate the checksum when the exclusive message to be transmitted has an address of aa bb cc ddH, and data or size of ee ffH.

$$\begin{aligned}
 aa + bb + cc + dd + ee + ff &= \text{total} \\
 \text{total} / 128 &= \text{quotient} \dots \text{remainder} \\
 128 - \text{remainder} &= \text{checksum}
 \end{aligned}$$

<Example 1> Setting the Performance Common REVERB TYPE to DELAY (DT1)

The "Parameter Address Map" indicates that the starting address of the Temporary Performance is 01 00 00 00H, that the Performance Common offset address is 00 00H, and that the REVERB TYPE address is 00 28H. Thus, the address is:

$$\begin{array}{r}
 01\ 00\ 00\ 00\text{H} \\
 \quad \quad \quad 00\ 00\text{H} \\
 +) \quad \quad \quad 00\ 28\text{H} \\
 \hline
 01\ 00\ 00\ 28\text{H}
 \end{array}$$

Since DELAY is parameter value 06H,

F0	41	10	6A	12	01 00 00 28	06	??	F7
(1)	(2)	(3)	(4)	(5)	address	data	checksum	(6)

(1) Exclusive status	(2) ID number (Roland)	(3) Device ID (17)
(4) Model ID (JV-1010)	(5) Command ID (DT1)	(6) EOX

Next we calculate the checksum.

$$\begin{aligned}
 01\text{H} + 00\text{H} + 00\text{H} + 28\text{H} + 06\text{H} &= 1 + 0 + 0 + 40 + 6 = 47 \text{ (sum)} \\
 47 \text{ (total)} / 128 &= 0 \text{ (quotient)} \dots 47 \text{ (remainder)} \\
 \text{checksum} &= 128 - 47 \text{ (quotient)} = 81 = 51\text{H}
 \end{aligned}$$

This means that the message transmitted will be F0 41 10 6A 12 01 00 00 28 06 51 F7.

<Example 2> Retrieving data for USER:03 Performance Part 3 (RQ1)

The "Parameter Address Map" indicates that the starting address of USER:03 is 10 02 00 00H, and that the offset address of Performance Part 3 is 12 00H. Thus, the address is:

$$\begin{array}{r}
 10\ 02\ 00\ 00\text{H} \\
 \quad \quad \quad 12\ 00\text{H} \\
 +) \quad \quad \quad 10\ 02\ 12\ 00\text{H} \\
 \hline
 10\ 02\ 12\ 00\text{H}
 \end{array}$$

Since the size of the Performance Part is 00 00 00 19H,

F0	41	10	6A	11	10 02 12 00	00 00 00 19	??	F7
(1)	(2)	(3)	(4)	(5)	address	size	checksum	(6)

(1) Exclusive status	(2) ID number (Roland)	(3) Device ID (17)
(4) Model ID (JV-1010)	(5) Command ID (RQ1)	(6) EOX

Next we calculate the checksum.

$$\begin{aligned}
 10\text{H} + 02\text{H} + 12\text{H} + 00\text{H} + 00\text{H} + 00\text{H} + 00\text{H} + 19\text{H} &= \\
 16 + 2 + 18 + 0 + 0 + 0 + 0 + 25 &= 61 \text{ (sum)}
 \end{aligned}$$

$$\begin{aligned}
 61 \text{ (total)} / 128 &= 0 \text{ (product)} \dots 61 \text{ (remainder)} \\
 \text{checksum} &= 128 - 61 \text{ (remainder)} = 67 = 43\text{H}
 \end{aligned}$$

Thus, a message of F0 41 10 6A 11 10 02 12 00 00 00 19 43 F7 would be transmitted.

<Example 3> Retrieving data for Temporary Performance (RQ1)

* When a data transfer is executed in Utility mode, data that is accessed will be the same as that which is transmitted when the Type parameter is set to PERFORM and the Source parameter is set to TEMP: -PATCH

The "Parameter Address Map" gives the following start addresses for Temporary Performance data.

01 00 00 00H	Temporary Performance Common
01 00 10 00H	Temporary Performance Part 1
:	
01 00 1F 00H	Temporary Performance Part 16

Since Performance Part has a size of 00 00 00 19H, we add that size to the start address of the Temporary Performance Part 16, resulting in:

```

01 00 1F 00H
+) 00 00 00 19H
-----
01 00 1F 19H
    
```

Thus, the Size for the retrieved data will be:

```

01 00 1F 19H
-) 01 00 00 00H
-----
00 00 1F 19H
    
```

F0	41	10	6A	11	01 00 00 00	00 00 1F 19	??	F7
(1)	(2)	(3)	(4)	(5)	address	size	checksum	(6)

- (1) Exclusive status
- (2) ID number (Roland)
- (3) Device ID (17)
- (4) Model ID (JV-1010)
- (5) Command ID (RQ1)
- (6) EOX

Calculating the checksum as shown in <Example 2>, we get a message of F0 41 10 6A 11 01 00 00 00 00 1F 19 47 F7 to be transmitted.

<Example 4> Retrieving the Temporary Performance data together with all Temporary Part and Rhythm Set data (RQ1)

* When a data transfer is executed in Utility mode, the data that is accessed will be the same as that which is transmitted when the Type parameter is set to PERFORM and the Source parameter is set to TEMP: +PATCH

The "Parameter Address Map" gives the following start addresses for Temporary Performance, Performance Mode Temporary Patch and Performance Mode Temporary Rhythm.

01 00 00 00H	Temporary Performance
02 00 00 00H	Performance Mode Temporary Patch (part 1)
:	
02 08 00 00H	Performance Mode Temporary Patch (part 9)
02 09 00 00H	Temporary Rhythm Setup
02 0A 00 00H	Performance Mode Temporary Patch (part 11)
:	
02 0F 00 00H	Performance Mode Temporary Patch (part 16)

The Patch offset addresses are as follows.

00 00H	Patch Common
10 00H	Patch Tone 1
:	
16 00H	Patch Tone 4

Since Patch Tone has a size of 00 00 01 01H, we add this size to the start address of Performance Mode Temporary Patch (Part 16) Tone 4, to get:

```

02 0F 00 00H
   16 00H
+) 00 00 01 01H
-----
02 0F 17 01H
    
```

Thus, the size of the retrieved data will be:

```

02 0F 17 01H
-) 01 00 00 00H
-----
01 0F 17 01H
    
```

F0	41	10	6A	11	01 00 00 00	01 0F 17 01	??	F7
(1)	(2)	(3)	(4)	(5)	address	size	checksum	(6)

- (1) Exclusive status
- (2) ID number (Roland)
- (3) Device ID (17)
- (4) Model ID (JV-1010)
- (5) Command ID (RQ1)
- (6) EOX

Calculating the checksum as shown in <Example 2>, we get a message of F0 41 10 6A 11 01 00 00 00 01 0F 17 01 57 F7 to be transmitted.

■ Scale Tune Function

(Model ID: 42H (GS), address: 40 1x 40H)

Scale Tune is a function that makes fine adjustments to the pitch of each note C-B. Settings are made for one octave, and applied to the notes of all octaves. By making Scale Tune settings you can use tunings and temperaments other than the standard Equal Temperament. Here we give three types of settings as examples.

* Scale tune messages for any parts are recognized in the patch mode.

○Equal Temperament

This temperament divides the octave into 12 equal steps, and is the temperament most frequently used today, especially in western music. Initially, the Scale Tune function of this instrument is set to Equal Temperament.

○Just Intonation (tonic of C)

The primary triads sound more beautiful in just intonation than in equal temperament. However, this applies only in one key, and chords will be discordant if you play in a different key. The settings here are for a tonic of C.

○Arabian-type Scale

The Scale Tune function allow you to use various tunings of ethnic music. Here is one of the Arabian scales.

Setting examples

Note	Equal Temp.	Just (in C)	Arabian-type Scale
C	0	0	-6
C#	0	-8	+45
D	0	+4	-2
Eb	0	+16	-12
E	0	-14	-51
F	0	-2	-8
F#	0	-10	+43
G	0	+2	-4
G#	0	+14	+47
A	0	-16	0
Bb	0	+14	-10
B	0	-12	-49

The values in the above table are in units of 1 cent. Convert these values to hexadecimal, and transmit them as exclusive data. For example to set the Scale Tune of Part 1 to an Arabian-type scale, transmit the following data.

F0 41 10 42 12 40 11 40 3A 6D 3E 34 0D 38 6B 3C 6F 40 36 0F 76 F7

■ ASCII Code Table

On the JV-1010, the following ASCII code set is used for processing data such as the Patch Name and the Performance Name.

D	H	Char	D	H	Char	D	H	Char
32	20H	SP	64	40H	@	96	60H	`
33	21H	!	65	41H	A	97	61H	a
34	22H	"	66	42H	B	98	62H	b
35	23H	#	67	43H	C	99	63H	c
36	24H	\$	68	44H	D	100	64H	d
37	25H	%	69	45H	E	101	65H	e
38	26H	&	70	46H	F	102	66H	f
39	27H	'	71	47H	G	103	67H	g
40	28H	(72	48H	H	104	68H	h
41	29H)	73	49H	I	105	69H	i
42	2AH	*	74	4AH	J	106	6AH	j
43	2BH	+	75	4BH	K	107	6BH	k
44	2CH	,	76	4CH	L	108	6CH	l
45	2DH	-	77	4DH	M	109	6DH	m
46	2EH	.	78	4EH	N	110	6EH	n
47	2FH	/	79	4FH	O	111	6FH	o
48	30H	0	80	50H	P	112	70H	p
49	31H	1	81	51H	Q	113	71H	q
50	32H	2	82	52H	R	114	72H	r
51	33H	3	83	53H	S	115	73H	s
52	34H	4	84	54H	T	116	74H	t
53	35H	5	85	55H	U	117	75H	u
54	36H	6	86	56H	V	118	76H	v
55	37H	7	87	57H	W	119	77H	w
56	38H	8	88	58H	X	120	78H	x
57	39H	9	89	59H	Y	121	79H	y
58	3AH	:	90	5AH	Z	122	7AH	z
59	3BH	;	91	5BH	[123	7BH	{
60	3CH	<	92	5CH	\	124	7CH	}
61	3DH	=	93	5DH]	125	7DH	~
62	3EH	>	94	5EH	^			
63	3FH	?	95	5FH	_			

D: decimal

H: hexadecimal

* SP indicates "space."

MIDI Implementation Chart

Function...		Transmitted	Recognized	Remarks
Basic Channel	Default	X	1-16	
	Changed	X	1-16	
Mode	Default	X	Mode 3	* 2
	Messages Altered	X *****	Mode 3, 4 (M = 1)	
Note Number :	True Voice	X *****	0-127 0-127	
Velocity	Note On	X	O	
	Note Off	X	O	
After Touch	Key's	X	O *1	
	Channel's	X	O *1	
Pitch Bend		X	O *1	
Control Change	0, 32	X	O *1	Bank select Modulation Breath type Foot type Portamento time Data entry Volume Balance Panpot Expression Hold 1 Portamento Sostenuto Soft Hold 2 Sound controller 2 Sound controller 3 Sound controller 4 Sound controller 5 General purpose controller 5 General purpose controller 6 General purpose controller 7 General purpose controller 8 Portamento control General purpose effects 1 General purpose effects 3 CC1 (General purpose controller 1) CC2 (General purpose controller 2) NRPN LSB, MSB RPN LSB, MSB
	1	X	O	
	2	X	O	
	4	X	O	
	5	X	O	
	6, 38	O *4	O	
	7	O *4	O	
	8	X	O	
	10	O *4	O	
	11	X	O	
	64	X	O	
	65	X	O	
	66	X	O	
	67	X	O	
	69	X	O	
	71	X	O (Resonance)	
	72	X	O (Decay Time)	
	73	X	O (Attack Time)	
	74	X	O (Cutoff)	
	80	X	O (Tone 1 Level)	
	81	X	O (Tone 2 Level)	
82	X	O (Tone 3 Level)		
83	X	O (Tone 4 Level)		
84	X	O		
91	O *4	O (Reverb)		
93	O *4	O (Chorus)		
1-5, 7-31, 64-95	*3	O		
1-5, 7-31, 64-95	*3	O		
98, 99	X	X		
100, 101	O *4	O		
Program Change :	True Number	O *4 *****	O *1 0-127	Program No. 1-128
System Exclusive		O *5	O *1	
System Common	: Song Position	X	X	
	: Song Select	X	X	
	: Tune Request	X	X	
System Real Time	: Clock	X	O *1	
	: Commands	X	X	
Aux Messages	: All Sound Off	X	O (120, 126, 127)	
	: Reset All Controllers	X	O	
	: Local On/Off	X	X	
	: All Notes Off	X	O (123-127)	
	: Active Sensing	X	O	
	: System Reset	X	X	
Notes		* 1 O X is selectable. * 2 Recognized as M=1 even if M≠1. * 3 Can be changed settings. * 4 Transmitted to an external MIDI device when a GM Data Transfer command is executed. * 5 Transmitted to an external MIDI device when a Data Transfer command is executed, or an RQ1 has been received.		

Mode 1 : OMNI ON, POLY
Mode 3 : OMNI OFF, POLY

Mode 2 : OMNI ON, MONO
Mode 4 : OMNI OFF, MONO

O : Yes
X : No

Specifications

JV-1010: 64 Voice Synthesizer Module (Conforms to General MIDI System)

● Number of Parts

16 (Part 10 is Rhythm Part)

● Maximum Polyphony

64 voices

● Effects

EFX: 40 sets

Reverb: 1 set (8 types)

Chorus: 1 set

● Preset Memory

Patches: 895 (640 same as the JV-2080 + 255 from "Session")

Performances: 64

Rhythm Sets: 18 (10 same as the JV-2080 + 8 from "Session")

● User Memory

Patches: 128

Performances: 32

Rhythm Sets: 2

● Wave Expansion Boards (sold separately)

Max. 1 Board

* *Each Wave Expansion Board includes Patches / Rhythm Sets that make use of the waves on the board.*

● Display

7 segments, 3 characters (LED)

● Connectors

Output Jacks (L(Mono), R)

Headphones Jack

MIDI Connectors (IN, OUT, THRU)

Computer Connector (Mac, PC-1, PC-2, MIDI)

● Power Supply

DC 9V (AC Adaptor)

● Current Draw

430 mA

● Dimensions

218 (W) x 237 (D) x 45 (H) mm

8-5/8 (W) x 9-3/8 (D) x 1-13/16 (H) inches

● Weight

1.4 kg / 3 lbs 2 oz (excluding AC Adaptor)

● Accessories

Owner's Manual

AC Adaptor (ACI/ACB Series)

CD-ROM (SoundDiver JV/XP, Reference Manual)

Rubber Feet

● Options

Wave Expansion Boards: SR-JV80 series

Rack Mount Adaptor: RAD-50

* *In the interest of product improvement, the specifications and/or appearance of this unit are subject to change without prior notice.*

Computer Cable Wiring Diagrams

For Apple Macintosh (Sold separately: RSC-15APL)

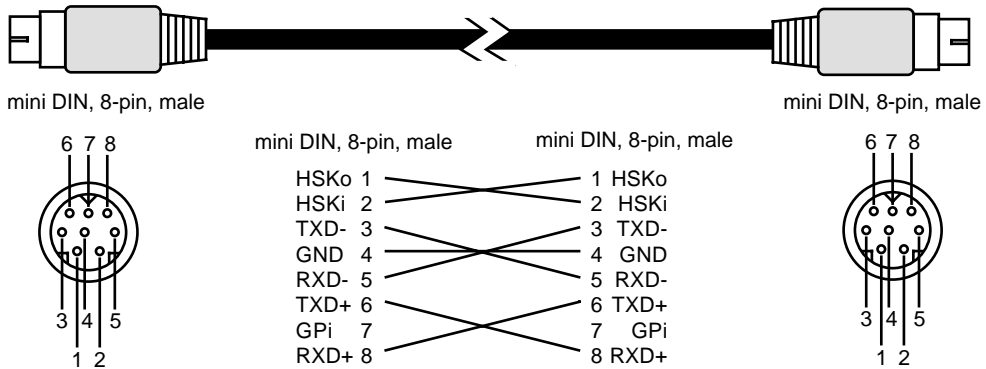

For PC (9-pin) (Sold separately: RSC-15AT)

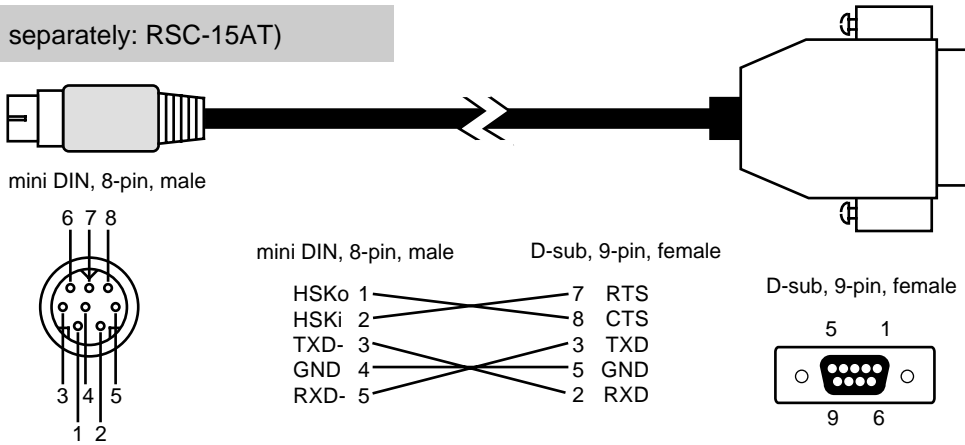

For PC (25-pin)

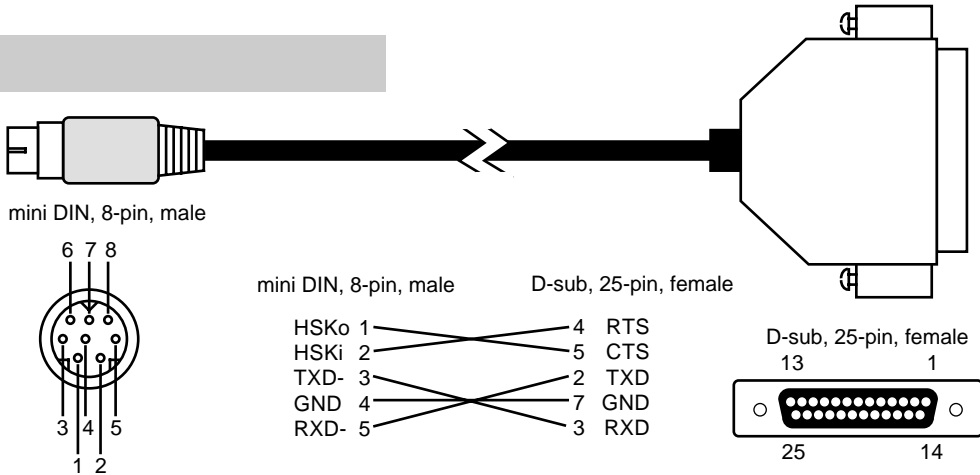

Index

- A**
- AC adaptor jack 12, 19
- C**
- CATEGORY/BANK knob 11
- Computer cable 40
- COMPUTER connector 12, 19, 40
- COMPUTER switch 12, 39
 - Mac 39
 - MIDI 41
 - PC-2 39
- Connection 18
 - Connecting to the COMPUTER connector 38
 - Connecting with MIDI connectors 41
- Cord hook 12
- D**
- DEMO 22
- Demo song
 - Composer profiles 23
 - Demo play 22
 - Listening to demo songs 22
- Desktop music 38
- Display 11
 - - - 17, 24, 27, 30–31
 - ALL 22
 - bFL 53
 - btL 53
 - coE 53
 - cSE 53
 - dtr 48
 - Fct 21
 - Gin 46
 - int 47
 - noP 53
 - Ply 22
 - PrA 28
 - rdE 53
 - Sur 21, 46–48
 - und 53
 - USr 27
- DTM 38
- E**
- Edit mode 44
- Error message
 - bFL 53
 - btL 53
 - coE 53
 - cSE 53
 - noP 53
 - rdE 53
 - und 53
- External MIDI device
 - Changing a performance from an external MIDI device 34
 - Changing a rhythm set from an external MIDI device 36
 - Changing patches from an external MIDI device 32
 - Transmitting settings to an external MIDI device 48
- F**
- Factory Reset 21
- G**
- GM
 - Entering GM mode 31
 - General MIDI system 10
 - GM mode 31
 - GM score data 31
 - Initializing GM mode 46
- M**
- MIDI connectors (IN, OUT, THRU) 12, 19
- MIDI indicator 11, 26
- MIDI interface 41
- MIDI keyboard 26
- MODE indicator 11
- Multitimbral sound generator 42
- O**
- OUTPUT jacks (L (MONO), R) 12, 19
- P**
- PART
 - Coarse Tune 45
 - Level 44
 - Pan 45
- PART knob 11
- Patch 24
 - Auditioning patches 25
 - Changing patches from an external MIDI device 32
 - Choosing patches 27
 - Choosing patches by bank 27
 - Choosing patches by category 28
 - Patch mode 25
 - PRESET-A–C, E 24
 - PRESET-D 24
 - Session 24
 - USER 24
 - WAVE-EXP 24
- PERFORM 43
- Performance
 - Changing a performance from an external MIDI device 34
 - Performance control channel 34
 - Performance mode 43
- PHONES jack 11, 19
- Phrase preview 25
- POWER switch 11, 20

R

Rack-mount adaptor	14
Receive channel	49
RHYTHM	30
Rhythm set	29
Changing a rhythm set from an external MIDI device	36
PRESET-A-C, E	29
PRESET-D	29
Rhythm set mode	30
Session	29
USER	29
WAVE-EXP	29
Rubber feet	14

S

SYSTEM	
Master Tune	50
Perform Ctrl CH	34, 49

T

Tuning	50
--------------	----

U

USER	27
UTILITY	
Data Transfer	48
Factory Reset	45
GM Initialize	46
Initialize	47

V

VALUE knob	11
VOLUME knob	11, 20

W

Wave expansion board	
Installing a wave expansion board	15
SR-JV80 series	15
WAVE-EXP	17

Apparatus containing Lithium batteries

ADVARSEL!

Lithiumbatteri - Eksplosionsfare ved fejlagtig håndtering.
Udskiftning må kun ske med batteri af samme fabrikat og type.
Levér det brugte batteri tilbage til leverandøren.

ADVARSEL

Eksplosjonsfare ved feilaktig skifte av batteri.
Benytt samme batteritype eller en tilsvarende type anbefalt av apparatfabrikanten.
Brukte batterier kasseres i henhold til fabrikantens instruksjoner.

CAUTION

Danger of explosion if battery is incorrectly replaced.
Replace only with the same or equivalent type recommended by the manufacturer.
Discard used batteries according to the manufacturer's instructions.

VARNING

Explosionsfara vid felaktigt batteribyte.
Använd samma batterityp eller en ekvivalent typ som rekommenderas av apparattillverkaren.
Kassera använt batteri enligt fabrikantens instruktion.

VAROITUS

Paristo voi räjähtää, jos se on virheellisesti asennettu.
Vaihda paristo ainoastaan laitevalmistajan suosittelemaan tyyppiin. Hävitä käytetty paristo valmistajan ohjeiden mukaisesti.



This product complies with the requirements of European Directive 89/336/EEC.

FEDERAL COMMUNICATIONS COMMISSION RADIO FREQUENCY INTERFERENCE STATEMENT

This equipment has been tested and found to comply with the limits for a Class B digital device, pursuant to Part 15 of the FCC Rules. These limits are designed to provide reasonable protection against harmful interference in a residential installation. This equipment generates, uses, and can radiate radio frequency energy and, if not installed and used in accordance with the instructions, may cause harmful interference to radio communications. However, there is no guarantee that interference will not occur in a particular installation. If this equipment does cause harmful interference to radio or television reception, which can be determined by turning the equipment off and on, the user is encouraged to try to correct the interference by one or more of the following measures:

- Reorient or relocate the receiving antenna.
- Increase the separation between the equipment and receiver.
- Connect the equipment into an outlet on a circuit different from that to which the receiver is connected.
- Consult the dealer or an experienced radio/TV technician for help.

Unauthorized changes or modification to this system can void the users authority to operate this equipment.
This equipment requires shielded interface cables in order to meet FCC class B Limit.

NOTICE

This Class B digital apparatus meets all requirements of the Canadian Interference-Causing Equipment Regulations.

AVIS

Cet appareil numérique de la classe B respecte toutes les exigences du Règlement sur le matériel brouilleur du Canada.

Information

When you need repair service, call your nearest Roland Service Center or authorized Roland distributor in your country as shown below.

AFRICA

EGYPT

Al Fanny Trading Office
9, EBN Hagar A1 Askalany Street,
ARD El Golf, Heliopolis,
Cairo 11341, EGYPT
TEL: 20-2-417-1828

REUNION

Maison FO - YAM Marcel
25 Rue Jules Hermann,
Chaudron - BP79 97 491
Ste Clotilde Cedex,
REUNION ISLAND
TEL: (0262) 218-429

SOUTH AFRICA

That Other Music Shop (PTY) Ltd.
11 Melle St., Braamfontein,
Johannesburg, SOUTH AFRICA

P.O.Box 32918, Braamfontein 2017
Johannesburg, SOUTH AFRICA
TEL: (011) 403 4105

Paul Bothner (PTY) Ltd.

17 Werdmuller Centre,
Main Road, Claremont 7708
SOUTH AFRICA

P.O.Box 23032, Claremont 7735,
SOUTH AFRICA
TEL: (021) 674 4030

ASIA

CHINA

Beijing Xinghai Musical Instruments Co., Ltd.
6 Huangmuhang Chao Yang
District, Beijing, CHINA
TEL: (010) 6774 7491

Shanghai Xingtong Acoustics Equipment CO.,Ltd.

5F, No.1500 Pingliang Road
New East Club Plaza, Shanghai,
CHINA
TEL: (021) 5580-0800

HONG KONG

Tom Lee Music Co., Ltd.
Service Division
22-32 Pun Shan Street, Tsuen
Wan, New Territories,
HONG KONG
TEL: 2415 0911

INDIA

Rivera Digtex (India) Pvt. Ltd.
409, Nirman Kendra Mahalaxmi
Flats Compound Off. Dr. Edwin
Moses Road, Mumbai-400011,
INDIA
TEL: (022) 498 3079

INDONESIA

PT Citra IntiRama
J1. Cideng Timur No. 151-150
Jakarta Pusat
INDONESIA
TEL: (021) 6324170

KOREA

Cosmos Corporation
1461-9, Seocho-Dong,
Seocho Ku, Seoul, KOREA
TEL: (02) 3486-8855

MALAYSIA

BENTLEY MUSIC SDN BHD
140 & 142, Jalan Bukit Bintang
55100 Kuala Lumpur, MALAYSIA
TEL: (03) 2144-3333

PHILIPPINES

G.A. Yupangco & Co. Inc.
339 Gil J. Puyat Avenue
Makati, Metro Manila 1200,
PHILIPPINES
TEL: (02) 899 9801

SINGAPORE

Swee Lee Company
150 Sims Drive,
SINGAPORE 387381
TEL: 846-3676

CRISTOFORI MUSIC PTE LTD

Blk 3014, Bedok Industrial Park E,
#02-2148, SINGAPORE 489980
TEL: 243 9555

TAIWAN

ROLAND TAIWAN ENTERPRISE CO., LTD.
Room 5, 9fl. No. 112 Chung Shan
N.Road Sec.2, Taipei, TAIWAN,
R.O.C.
TEL: (02) 2561 3339

THAILAND

Theera Music Co., Ltd.
330 Vereng NakornKasem, Soi 2,
Bangkok 10100, THAILAND
TEL: (02) 2248821

VIETNAM

Saigon Music
138 Tran Quang Khai St.,
District 1
Ho Chi Minh City
VIETNAM
TEL: (08) 844-4068

AUSTRALIA/ NEW ZEALAND

AUSTRALIA

Roland Corporation Australia Pty., Ltd.
38 Campbell Avenue
Dee Why West. NSW 2099
AUSTRALIA
TEL: (02) 9982 8266

NEW ZEALAND

Roland Corporation Ltd.
32 Shaddock Street, Mount Eden,
Auckland, NEW ZEALAND
TEL: (09) 3098 715

CENTRAL/LATIN AMERICA

ARGENTINA

Instrumentos Musicales S.A.
Av.Santa Fe 2055
(1123) Buenos Aires
ARGENTINA
TEL: (011) 4508-2700

BRAZIL

Roland Brasil Ltda
Rua San Jose, 780 Sala B
Parque Industrial San Jose
Cotia - Sao Paulo - SP, BRAZIL
TEL: (011) 4615 5666

COSTA RICA

JUAN Bansbach Instrumentos Musicales
Ave.1. Calle 11, Apartado 10237,
San Jose, COSTA RICA
TEL: 258-0211

CHILE

Comercial Fancy II S.A.
Rut.: 96.919.420-1
Nataníel Cox #739, 4th Floor
Santiago - Centro, CHILE
TEL: (02) 688-9540

EL SALVADOR

OMNI MUSIC
75 Avenida Norte y Final
Alameda Juan Pablo II,
Edificio No.4010 San Salvador,
EL SALVADOR
TEL: 262-0788

MEXICO

Casa Veerkamp, s.a. de c.v.
Av. Toluca No. 323, Col. Olivar
de los Padres 01780 Mexico D.F.
MEXICO
TEL: 668-0480

PANAMA

SUPRO MUNDIAL, S.A.
Boulevard Andrews, Albrook,
Panama City, REP. DE PANAMA
TEL: 315-0101

PARAGUAY

Distribuidora De Instrumentos Musicales
J.E. Olear y ESQ. Manduvira
Asuncion PARAGUAY
TEL: (021) 492-124

PERU

VIDEO Broadcast S.A.
Portinari 199 (ESQ. HALS),
San Borja, Lima 41,
REP. OF PERU
TEL: (01) 4758226

URUGUAY

Todo Musica S.A.
Francisco Acuna de Figueroa 1771
C.P.: 11.800
Montevideo, URUGUAY
TEL: (02) 924-2335

VENEZUELA

Musicland Digital C.A.
Av. Francisco de Miranda,
Centro Parque de Cristal, Nivel
C2 Local 20 Caracas
VENEZUELA
TEL: (212) 285-8586

EUROPE

AUSTRIA

Roland Austria GES.M.B.H.
Siemensstrasse 4, P.O. Box 74,
A-6063 RUM, AUSTRIA
TEL: (0512) 26 44 260

BELGIUM/HOLLAND/ LUXEMBOURG

Roland Benelux N. V.
Houtstraat 3, B-2260, Oevel
(Westerlo) BELGIUM
TEL: (014) 575811

DENMARK

Roland Scandinavia A/S
Nordhavnsvej 7, Postbox 880,
DK-2100 Copenhagen
DENMARK
TEL: (039)16 6200

FRANCE

Roland France SA
4, Rue Paul Henri SPAAK,
Parc de l'Esplanade, F 77 462 St.
Thibault, Lagny Cedex FRANCE
TEL: 01 600 73 500

FINLAND

Roland Scandinavia As, Filial Finland
Lauttasaarentie 54 B
Fin-00201 Helsinki, FINLAND
TEL: (9) 682 4020

GERMANY

Roland Elektronische Musikinstrumente HmbH.
Oststrasse 96, 22844 Norderstedt,
GERMANY
TEL: (040) 52 60090

GREECE

STOLLAS S.A. Music Sound Light
155, New National Road
Patras 26442, GREECE
TEL: (061) 43-5400

HUNGARY

Intermusica Ltd.
Warehouse Area 'DEPO' Pf.83
H-2046 Torokbalint, HUNGARY
TEL: (23) 511011

IRELAND

Roland Ireland
Audio House, Belmont Court,
Donnybrook, Dublin 4,
Republic of IRELAND
TEL: (01) 2603501

ITALY

Roland Italy S. p. a.
Viale delle Industrie 8,
20020 Arese, Milano, ITALY
TEL: (02) 937-78300

NORWAY

Roland Scandinavia Avd. Kontor Norge
Lilleakerveien 2 Postboks 95
Lilleaker N-0216 Oslo
NORWAY
TEL: 273 0074

POLAND

P. P. H. Brzostowicz
UL. Gibraltarska 4,
PL-03664 Warszawa POLAND
TEL: (022) 679 44 19

PORTUGAL

Tecnologias Musica e Audio, Roland Portugal, S.A.
Cais Das Pedras, 8/9-1 Dto
4050-465 PORTO
PORTUGAL
TEL: (022) 608 00 60

ROMANIA

FBS LINES
Piata Libertatii 1,
RO-4200 Gheorgheni
TEL: (095) 169-5043

RUSSIA

MuTek
3-Bogatyrskaya Str. 1.k.l
107 564 Moscow, RUSSIA
TEL: (095) 169 5043

SPAIN

Roland Electronics de España, S. A.
Calle Bolivia 239, 08020
Barcelona, SPAIN
TEL: (93) 308 1000

SWEDEN

Roland Scandinavia A/S SWEDISH SALES OFFICE
Danvik Center 28, 2 tr.
S-131 30 Nacka SWEDEN
TEL: (08) 702 0020

SWITZERLAND

Roland (Switzerland) AG Musitronic AG
Gerberstrasse 5, Postfach,
CH-4410 Liestal, SWITZERLAND
TEL: (061) 927-8383

UKRAINE

TIC-TAC
Mira Str. 19/108
P.O. Box 180
295400 Munkachevo, UKRAINE
TEL: (03131) 414-40

UNITED KINGDOM

Roland (U.K.) Ltd.
Atlantic Close, Swansea
Enterprise Park, SWANSEA
SA7 9FI,
UNITED KINGDOM
TEL: (01792) 700139

MIDDLE EAST

BAHRAIN

Moon Stores
No.16, Bab Al Bahrain Avenue,
P.O.Box 247, Manama 304,
State of BAHRAIN
TEL: 211 005

CYPRUS

Radex Sound Equipment Ltd.
17, Diagorou Street, Nicosia,
CYPRUS
TEL: (02) 66-9426

IRAN

MOCO, INC.
No.41 Nike St., Dr.Shariyati Ave.,
Roberoye Cerahe Mirdamad
Tehran, IRAN
TEL: (021) 285-4169

ISRAEL

Halilit P. Greenspoon & Sons Ltd.
8 Retzif Ha'aliya Hashnya St.
Tel-Aviv-Yafo ISRAEL
TEL: (03) 6823666

JORDAN

AMMAN Trading Agency
245 Prince Mohammad St.,
Amman 1118, JORDAN
TEL: (06) 464-1200

KUWAIT

Easa Husain Al-Yousifi
Abdullah Salem Street,
Safat, KUWAIT
TEL: 243-6399

LEBANON

A. Chahine & Fils
Gerge Zeidan St., Chahine Bldg.,
Achrafieh, P.O.Box: 16-5857
Beirut, LEBANON
TEL: (01) 20-1441

QATAR

Al Emadi Co. (Badie Studio & Stores)
P.O. Box 62,
Doha, QATAR
TEL: 4423-554

SAUDI ARABIA

aDawlih Universal Electronics APL
Corniche Road, Aldossary Bldg.,
1st Floor, Alkhobar,
SAUDI ARABIA

P.O.Box 2154, Alkhobar 31952

SAUDI ARABIA
TEL: (03) 898 2081

SYRIA

Technical Light & Sound Center
Bldg. No. 47,
Khaled Ebn Al Walid St.
Damascus, SYRIA
TEL: (011) 221-1230

TURKEY

Barkat muzik aletleri ithalat ve ihracat Ltd Sti
Siraselvililer Caddesi Siraselvililer
Pasajı No:74 /20
Taksim - Istanbul, TURKEY
TEL: (0212) 2499324

U.A.E.

Zak Electronics & Musical Instruments Co. L.L.C.
Zabeel Road, Al Sherooq Bldg.,
No. 14, Grand Floor, Dubai, U.A.E.
TEL: (04) 3360715

NORTH AMERICA

CANADA

Roland Canada Music Ltd. (Head Office)
5480 Parkwood Way Richmond
B. C., V6V 2M4 CANADA
TEL: (0604) 270 6626

Roland Canada Music Ltd. (Toronto Office)
Unit 2, 109 Woodbine Downs
Blvd, Etobicoke, ON
M9W 6Y1 CANADA
TEL: (0416) 213 9707

U. S. A.

Roland Corporation U.S.
5100 S. Eastern Avenue
Los Angeles, CA 90040-2938,
U. S. A.
TEL: (323) 890 3700

As of January 1, 2002 (Roland)

